

DUTY GEAR //



**THE SAFARILAND
GROUP**

// PRODUCTS CATALOG

DUTY GEAR



INNOVATION NOT IMITATION

Safariland® holsters and accessories are renowned for quality, performance and technological advancements in design. The overwhelming choice of law enforcement agencies and competition shooters around the world, Safariland continues to develop new products by working hands on with the most knowledgeable and experienced users in the industry. From veteran law enforcement officers to our world-renowned Team Safariland shooters, we field test our products to provide you with the best product available.



- 63** // DUTY HOLSTERS
- 66** // EDW HOLSTERS
- 69** // DUTY BELTS & ACCESSORIES
- 76** // TACTICAL & MILITARY
- 83** // GUN CASES
- 84** // QUICK ATTACHMENT SYSTEMS
- 88** // LIGHT SYSTEMS
- 90** // CONCEALMENT
- 98** // COMPETITION

SAFARILAMINATE™ CONSTRUCTION

SafariLaminate™ is a unique thermal-laminate process used for the construction of many Safariland® products. This material is impervious to moisture, bloodborne pathogens, and does not break down like natural materials, making for an extremely durable and long-term professional looking product.

SAFARILAND FINISHES / COLORS

Traditional Leather Look - SafariLaminate construction offered in Plain, Basketweave and Hi Gloss

STX Tactical® - SafariLaminate construction with an exclusive "haircell" finish. It's famous for its incredible strength and abrasion-resistance, available in several colors

STX SafariLaminate construction offered in Plain, Basketweave and Hi Gloss

SafariSeven - An injection molded design with a proprietary nylon blend completely non-abrasive to the firearm's finish

STX TACTICAL® COLORS AVAILABLE



The ALS® or Automatic Locking System provides a high level of security without adding thumb breaks, snaps, or levers requiring the use of the trigger finger.



1. The ALS is a unique design that locks into the ejection port and is operated by the thumb once the SLS is released.
2. The SLS rotating hood has been tested and proven for many years on the 6280 and 6004 series of holsters. Simply push down and rotate forward as you obtain your shooting grip. To close, pull back on the hood, and the SLS self locks. There are no snaps or straps to manipulate.
3. The Hood Guard helps protect the SLS from impact and premature release, especially in an attempted takeaway. Included with all duty and tactical versions.
4. Constructed of SafariLaminate™, a thermal-molded holster to help protect the handgun and gun-mounted accessories for years of use.



The SLS rotating hood has been tested and proven for many years on the 6280 and 6004 series of holsters. Simply push down and rotate forward as you obtain your shooting grip.



1. The SLS rotating hood has been tested and proven for many years on the 6280 and 6004 series of holsters. Simply push down and rotate forward as you obtain your shooting grip. To close, pull back on the hood, and the SLS self locks. There are no snaps or straps to manipulate.
2. The Hood Guard helps protect the SLS from impact and premature release, especially in an attempted takeaway. Included with all duty and tactical versions.
3. Optional Sentry lever increases retention level by one.



Much like the ALS® with its intuitive draw, the GLS™ or Grip Locking System, is automatically disengaged when taking a shooting grip.



1. The GLS retention device operated by the middle finger, simply obtain a shooting grip to release the mechanism.
2. Automatically locks weapon in place upon holstering.



LEVEL I RETENTION™

RETENTION LEVELS

Officer safety is critical. That's why Safariland® created the Retention Level system as a guide to holster selection. The holsters in this catalog are classified by their Retention Levels to help you choose the right holster for your needs. In the interest of safety for police officers, Safariland introduced the Retention Level System in 1985, providing useful holster selection information to the marketplace. This system helped officers evaluate and make informed decisions on the type of holster needed for different scenarios and environments. Safariland set this initial standard, and to this day is the only holster manufacturer with established, strict testing criteria to evaluate the Retention Level of a duty holster.

ARMOR
COMMUNICATIONS
DUTY GEAR
BIKE
FIREARMS ACCESSORIES
LETHAL
PROTECTIVE GEAR
FORENSICS
PERFORMANCE APPAREL
ARMOR SYSTEMS
SURVIVABILITY SYSTEMS
TRAINING GROUP



NEW

PATENTED

6392
// WITH HI-RIDE UBL

- Hi-ride version



PATENTED

6395
// WITH LOW-RIDE UBL

- 1.5" (38mm) Belt Drop version



PATENTED

ALS
automatic locking system

6390
// ALS® LEVEL I WITH MID-RIDE UBL

- ALS® (Automatic Locking System) secures weapon once holstered; simple straight up draw once the release is deactivated
- Optional ALS Guard available for increasing level of security by one to Level II Retention™
- Open-top design without SLS for quick retrieval of weapon
- SafariLaminate™ thermal-molded construction protects handgun and sights
- Available in STX finishes



PATENTED & PATENT PENDING

7TS

7390
// 7TS™ ALS® LEVEL I RETENTION™ MID-RIDE DUTY HOLSTER

- ALS® (Automatic Locking System) secures weapon once holstered; simple straight up draw once release is deactivated
- Open-top design without SLS for quick retrieval of weapon
- Optional ALS Guard available for increasing level of security by one to a Level II Retention™
- A proprietary nylon blend that is completely non-abrasive to a firearm's finish
- Raised stand-off surfaces in holster's interior creates air space around the weapon, allowing dirt and moisture to quickly clear any contact with the firearm
- Very high heat and low cold tolerances; structurally sound from 300° F to -50° F
- Available in SafariSeven™ Plain Black and FDE Brown finishes



NEW

PATENTED & PATENT PENDING

7392
// WITH HI-RIDE UBL

- Hi-ride version



PATENTED & PATENT PENDING

7395
// WITH LOW-RIDE UBL

- 1.5" (38mm) Belt Drop version



2
// HI-RIDE LEVEL I RETENTION™ DUTY

- Hi-ride version



2005
// WITH LOW-RIDE UBL

- 1.5" (38mm) Belt Drop version



200
// TOP GUN LEVEL I RETENTION™ WITH MID-RIDE UBL

- Features a top draw, mid-ride, straight-drop cant and a thumb break with a one-way directional snap
- Adjustable holster tensioning device easily allows the controlling of friction with the turn of a screw
- Available in Plain Black, Basketweave, Hi Gloss or Nylon Look finishes

LEVEL II RETENTION™



NEW

6282 // WITH HI-RIDE UBL

- Hi-ride version



6285 // WITH LOW-RIDE UBL

- 1.5" (38mm) Belt Drop version



6280 // SLS LEVEL II RETENTION™ WITH MID-RIDE UBL

- SLS (Self Locking System) Rotating Hood
- Top draw and straight-drop cant
- Level III Retention™ with optional Sentry installed
- Fits available for light mounted weapons
- Available in Plain Black, Basketweave, Hi Gloss, Nylon Look, STX or STX Tactical® finishes (all colors)

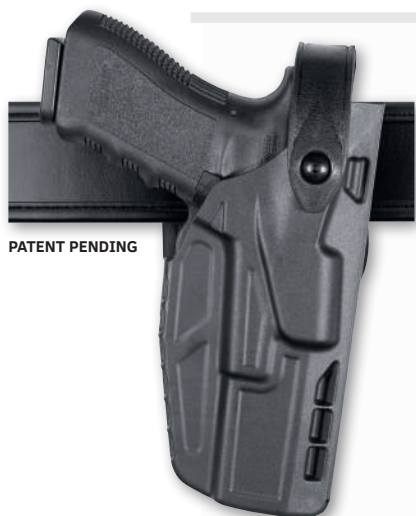

PATENT PENDING

7280 // 7TS™ SLS MID-RIDE LEVEL II RETENTION™

- SLS (Self Locking System) Rotating Hood
- Level III Retention™ with optional Sentry installed
- A proprietary nylon blend that is completely non-abrasive to a firearm's finish
- Raised stand-off surfaces in holster's interior creates air space around the weapon allowing dirt and moisture to quickly clear any contact with the firearm
- Very high heat and low cold tolerances; structurally sound from 300° F to -50° F
- Available in SafariSeven™ Plain Black and FDE Brown finishes



NEW

PATENT PENDING

7282 // WITH HI-RIDE UBL

- Hi-ride version



PATENT PENDING

7285 // WITH LOW-RIDE UBL

- 1.5" (38mm) Belt Drop version



2955 // WITH LOW-RIDE UBL

- 1.5" (38mm) Belt Drop version



295 // LEVEL II RETENTION™ WITH MID-RIDE UBL

- Features front wraparound thumb break and an internal trigger guard lock for secure weapon retention
- Mid-ride belt position and slightly forward grip cant allow for comfortable carry and quick, easy draw
- Offered in 2" (50mm) or 2.25" (58mm) belt slots
- Available in Plain Black, Basketweave, Hi Gloss or Nylon Look finishes

LEVEL III & IV RETENTION

ALS
automatic locking system

6360
// ALS®/SLS MID-RIDE
LEVEL III RETENTION™



PATENTED

- ALS® (Automatic Locking System) secures weapon once holstered
- SLS (Self Locking System) Rotating Hood
- Level IV Retention™ with optional Sentry installed
- Slim, compact design allows weapon to ride close to body
- Simple straight up draw once all releases are deactivated
- Available in Plain Black, Basketweave, Hi Gloss, Nylon Look, STX or STX Tactical® finishes (all colors)



PATENTED

NEW

6362
// WITH HI-RIDE UBL

- Hi-ride version



PATENTED

6365
// WITH LOW-RIDE UBL

- 1.5" (38mm) Belt Drop version



PATENTED &
PATENT PENDING

NEW

7362
// WITH HI-RIDE UBL

- Hi-ride version



PATENTED &
PATENT PENDING

7365
// 7TS™ ALS®/SLS WITH
LOW-RIDE UBL

- 1.5" (38mm) Belt Drop version



PATENTED &
PATENT PENDING

7360
// 7TS™ ALS®/SLS MID-RIDE
LEVEL III RETENTION™

- ALS® (Automatic Locking System) secures weapon once holstered; simple straight up draw once release is deactivated
- SLS (Self Locking System) Rotating Hood
- Level IV Retention™ with optional Sentry installed
- A proprietary nylon blend that is completely non-abrasive to a firearm's finish
- Raised stand-off surfaces in holster's interior creates air space around the weapon allowing dirt and moisture to quickly clear any contact with the firearm
- Very high heat and low cold tolerances; structurally sound from 300° F to -50° F
- Available in SafariSeven™ Plain Black and FDE Brown finishes



070
// SSIII LEVEL III RETENTION™ WITH
MID-RIDE UBL

- Mid-ride belt position and slightly forward grip cant allow for comfortable carry and quick, easy draw
- Top thumb break and middle finger release tab, internal ejection port lock
- Offered for 2.25" (58mm) belt slot only
- Available in Plain Black, Basketweave, Hi Gloss or Nylon Look finishes



0705
// WITH LOW-RIDE UBL

- 1.5" (38mm) Belt Drop version

ARMOR
COMMUNICATIONS

DUTY
GEAR

BIKE

FIREARMS
ACCESSORIES

LESS
LETHAL

PROTECTIVE
GEAR

FORENSICS

PERFORMANCE
APPAREL

ARMOR
SYSTEMS

SURVIVABILITY
SYSTEMS

TRAINING
GROUP

EDW HOLSTERS

Safariland® offers a wide array of holster models to address the market expansion in the use of EDWs, or electronic discharge weapons. The Safariland SLS, ALS® and other safety features have improved the offerings of the EDW holster from a simple device to hold a weapon into a Retention Level-quality holster.



6520 // SLS EDW HOLSTER WITH CLIP

- Level II Retention™ holster
- SLS (Self Locking System) Rotating Hood
- Clip-on style belt loop with ability to fit 1.5" (38mm), 1.75" (45mm), 2" (50mm) or 2.25" (58mm); belt clip is user-adjustable for cant angle
- Designed for vertical or cross draw carry
- Closed bottom with drain hole to protect cartridge and officer
- SafariLaminate™ construction with suede lining
- Available in Plain Black, Basketweave, Hi Gloss, Nylon Look, STX or STX Tactical® finishes (all colors)



520 // THUMB BREAK CLIP-ON STYLE

- SafariLaminate™ construction with suede lining
- Clip-on style belt loop with the ability to fit 1.5" (38mm), 1.75" (45mm), 2" (50mm) or 2.25" (58mm) belts
- Belt clip is user-adjustable for cant angle; designed for vertical or cross draw carry
- Closed bottom with drain hole to protect cartridge and officer
- Available in Plain Black, Basketweave or Hi Gloss finishes



BACK



6342 // ALS® EDW HOLSTER WITH CLIP

- Level I Retention™ holster
- ALS® (Automatic Locking System) securely locks the electronic discharge weapon into place without any straps or snaps to manipulate
- Standard ride with belt clip that fits 1.5" (38mm), 1.75" (45mm), 2" (50mm) and 2.25" (58mm) belt widths
- Ergonomically designed ALS release that is completely operable with the thumb; depress lever, slightly rock back to draw
- Thermal-molded SafariLaminate™ construction protects EDW and sights
- Available in STX finishes



ALS
automatic locking system
6312
// AMBIDEXTROUS
VERSION



5122 // OPEN TOP EDW WITH BELT CLIP

- Safety on the Taser® EDW is automatically activated once the weapon is reholstered
- Trigger guard detent offers reliable weapon retention
- Thermal-molded SafariLaminate™ construction protects EDW and sights
- Open-top design allows for quick draw and reholstering
- Closed bottom with drain hole protects cartridge and officer
- Comes standard with 745BL Belt Clip offering 3 different cants
- Fits belts from 1.5" (38mm) to 2.25" (58mm) in width
- Available in STX Tactical® (all colors), STX Plain, STX Basketweave, or STX Hi Gloss finishes



6287 // SLS EDW BELT LOOP

- Level II Retention™ holster
- Rides close to body
- SLS (Self Locking System) Rotating Hood
- Adjustable cant, can be worn strongside or cross draw
- Closed bottom with drain hole to protect cartridge and officer
- SafariLaminate™ construction with suede lining
- Available in Plain Black or STX Tactical® finishes



521-CAP // EDW CARTRIDGE ACCESSORY PLATE

- Attaches to the 745BL Belt Clip
- Provides convenient storage area for additional EDW cartridge
- Available for Models 520 & 6520
- Available in Plain Black, Basketweave, Hi Gloss or Nylon Look finishes
- Holster sold separately

HOLSTER DUTY ACCESSORIES

HOLSTER MOUNTING PLATFORMS

Safariland® offers the broadest line of holsters for law enforcement, so it follows that we would also provide the most extensive line of mounting platforms and accessories for our holsters. These options add versatility, comfort, and convenience as you perform your duties.

UNIVERSAL BELT LOOP

// (UBL) STYLES

- Will not pinch or add pressure to hip bone (support ridge removed from the belt shank)
- Locks onto the duty belt with belt slot design, no belt tension screws needed; will not damage top of belt
- Compatible with any holster with the 3-hole pattern

RIDE HEIGHTS FOR VARIOUS BODY STYLES



Mid-ride: standard ride height



Low-ride: drop version 1.5" below waist



Mid-ride with HDA: drop version 2" below waist

6070UBL-PAD 6075UBL-PAD

- Provides a soft pad between the body and Universal Belt Loop (UBL)
- Helps address comfort issues associated with wearing a duty belt for long periods of time
- Works equally well for both male and female officers



6070UBL
// 2" OR 2.25"
MID-RIDE UBL



6075UBL
// 2" OR 2.25"
LOW-RIDE UBL



6072UBL
// 2" OR 2.25"
HI-RIDE UBL



P2201
// CONVERTS 2.25" UBL TO
A 2" BELT SLOT



6281HDA
// DROPS HOLSTER BY 2"

SPACER KITS

Spacer kits are available that position the holster away from the body to accommodate various body shapes. The kits are designed for use with Safariland 3-hole pattern holsters and tactical accessories.



// T-SPACER-KIT

- Positions holster farther away from body for a smooth and comfortable draw
- For use on holsters only



// HDA-KIT

- Designed to lower holster by 2" (50mm)
- For use on holsters only, right and left hand specific



// OVAL SPACER-KIT

- Positions upper portion of holster farther away from body without spacing the bottom any further, giving an increased "outward" cant



// CUSTOMIZED-KIT

- Positions holster farther away from body for a smooth and comfortable draw
- For use with holsters or accessories

HOLSTER MOUNTING PLATFORMS



566BL

- Rides 1" or 2" higher than standard 567BL belt loop
- Fit belt widths up to 1.5" (38mm)



567BL // 1.5" TO 2.25"

- Seven different options available up to 2.25"



745BL // BELT CLIP

- Designed with a 3-hole pattern, allowing interchangeability among various Safariland holsters
- Clips on/off belt without having to remove other accessories on rig
- Made of durable nylon; will pass a Level I Retention™ pull test
- Fits belt widths from 1.5" (38mm) to 2.25" (58mm)

PATENTED



568BL // UP TO 1.75"

- Fits up to 1.75" belt widths
- No belt necessary for use



NEW

565BL // HI-RIDE CONCEALMENT BELT LOOP

- Can be used on any Safariland® 3-hole pattern holster
- Available in 1.5" and 1.75" belt widths



6004-DFA // DROP FLEX ADAPTER

- Allows user to wear a thigh rig below the hip without shifting weight farther down the leg
- Keeps rig from sliding on belt
- Can be used on belt widths up to 2.25" (58mm)
- For use in conjunction with the 6004-10 Leg Shroud



6004-UFA // UNIVERSAL FLEX ADAPTER

- Allows user to wear a thigh rig below the hip without shifting weight farther down the leg
- Hole pattern on UFA makes connecting to various mounts possible, including the 568BL Paddle, ELS Fork, QLS Fork, or 745BL Belt Clip
- For use in conjunction with 6004-10 Leg Shroud



with QLS

with ELS



with 568BL

DUTY BELTS

• All belts available in Black unless otherwise specified, and buckles are offered in a choice of chrome or brass finish



031
// D-RING BELT 1.5" (38mm)

- Reinforced instructor-style belt
- Lined with loop material



51
// GARRISON WITH SQUARE BUCKLE 1.75" (45mm)

- Full grain leather construction
- Includes removable square chrome or brass buckle



99/999
// BUCKLELESS™ REVERSIBLE BELT 1.5" (38mm)

- Loop can be worn on the outside, creating a Buckleless system
- Order 999 for belt without loop lining



992
// REVERSIBLE SAFARILAMINATE™ BELT 1.5" (38mm)

- Lined with loop material
- Designed to be worn under duty belts with hook as the foundation of the Safariland® Buckleless™ system
- The 992 is the contour version of the 99



942
// CONTOURED BUCKLELESS™ BELT 2" (50mm) OR 2.25" (58mm)

- Tip of belt points to the right side of the officer
- Greater all-day comfort by distributing weight evenly; no sharp edges to dig into hips
- Lined with hook to mate with 99 underbelt
- Features a hidden brass hook closure



94/94P
// BUCKLELESS™ BELT 2.25" (58mm)

- Features a hidden brass hook and a hook and loop closure on both ends
- Belt is lined with a band of hook and loop and attaches to the lining on the Model 99 or 992, completing the Buckleless system
- 94P without hook and loop



87/87V
// SAM BROWNE BELT 2.25" (58mm)

- Standard duty belt with a suede lining
- 4-stitch design with free-sliding keeper to hold belt tip in place
- Double-tongued buckle and center belt stud fasten belt firmly around waist
- 87V with hook lining



146/146V
// BORDER PATROL WITH BUCKLE 2.25" (58mm)

- Billeted belt design with 1.25" billets and buckle
- The 1.25" (32mm) and 2.25" (58mm) keepers hold the interior and exterior belt tips in place
- 146V version features hook lining



872
// CONTOURED BELT 2.25" (58mm)

- 4-stitch design with suede lining and free-sliding keeper to hold belt tip in place
- 2.25" (58mm) duty belt is contoured for proper alignment and greater comfort
- Greater all-day comfort; no sharp edges to dig into hips



875
// SAM BROWNE STITCHED EDGE BELT 2.25" (58mm)

- Standard duty belt with a plain border stitch
- Double-tongued buckle and center belt stud fasten belt firmly around waist

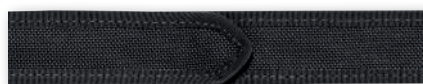

4325
// NYLON BUCKLELESS™ REVERSIBLE BELT 1.5" (38mm)

- Hook and loop closure
- Lined with loop material



4332
// ELS™ TACTICAL BELT 2" (50mm)

- Features full length hook lining
- Buckleless™ design features two large knobs for locking in ELS mounting holes
- Pre-cut ELS mounting holes for straight up or angled attachment of ELS Receiver Plates
- Available in Nylon Look, Tan or Foliage Green finishes
- ELS sold separately (see page 84)



832
// QAS DUTY BELT 2.25" (58mm)

- Pre-cut ELS (Equipment Locking System) and QLS (Quick Locking System) holes in the belt for mounting ELS 35 and QLS 22 Receiver Plates
- Buckleless™ design features two large studs that fit into pre-cut holes instead of buckle
- Features full length hook lining
- Available in Nylon Look, Plain Black, Basketweave or Hi Gloss finishes
- ELS and QLS sold separately (see page 84)



4832
// LIGHTWEIGHT DUTY BELT 2.25" (58mm)

- Full length hook lining for use with Safariland Model 99 or 4325
- Buckleless™ design featuring hidden brass hook
- Up to 30% lighter than standard duty belts



4320
// PADDED BELT LINER

- Provides a padded buffer between duty belt and body
- Helps eliminate possible bruising and other comfort issues associated with wearing a duty belt for long periods of time

ARMOR
COMMUNICATIONS
DUTY GEAR
BIKE
FIREARMS ACCESSORIES
LETHAL
PROTECTIVE GEAR
FORENSICS
PERFORMANCE APPAREL
ARMOR SYSTEMS
SURVIVABILITY SYSTEMS
TRAINING GROUP

SLS/ALS® ACCESSORIES

Four uniquely designed accessories for Safariland® duty holsters with the SLS (Self Locking System) and ALS® (Automatic Locking System) systems. Available for the following models:

- SLS: 6004, 6005, 6034, 6035, 6230, 6235, 6280, 6285, 6287, 6520, 7004, 7005, 7280 and 7285
- ALS®: 6304, 6305, 6354, 6355, 6360, 6365, 6384, 6385, 6390, 6395, 7304, 7305, 7354, 7355, 7360, 7365, 7384, 7385, 7390 and 7395

SLS (SELF LOCKING SYSTEM)



6000
// SLS HOOD GUARD

- Features a uniquely designed accessory protection for the SLS holster system
- Will adapt to any SLS holster
- Colors: Black, Tan, Foliage Green



6001
// SLS SENTRY

- Features a uniquely designed accessory protection for the SLS holster system
- Will adapt to any SLS holster and increase the retention level by one
- Color: Black



6002
// SLS SENTRY & HOOD GUARD

- Features the Sentry installed into the Hood Guard
- Will adapt to any SLS holster
- Colors: Black, Tan, Foliage Green
- Sentry only available in Black

ALS™ (AUTOMATIC LOCKING SYSTEM)



6006
// ALS® GUARD

- Provides additional security for select ALS® concealment, tactical and duty holsters
- Fits the following models: 6354, 6355, 6377, 6378, 6379, 6384, 6385, 6390, 6395, 7354, 7355, 7378, 7377, 7379, 7384, 7385, 7390 and 7395
- Covers ALS lever to prevent any accidental or unauthorized use
- Can be retrofitted onto existing ALS concealment holsters
- Color: Black



DUTY ACCESSORIES

- Durable SafariLaminate™ construction for long-lasting wear
- All accessories are designed to fit 2.25" (58mm) duty belts unless otherwise specified
- Finishes offered: traditional leather look; in Plain, Basketweave or Hi Gloss; STX Tactical® in all colors
- Many Safariland® duty accessories are available with hidden snap closure. Visit safariland.com/safariland
- Snap versions available in Chrome, Brass or Black

NOTE: Items noted with (*) are available in STX finish



78* // SLIMLINE DOUBLE MAGAZINE POUCH

- Magazines are oriented "bullets out" to save space on belt
- Optimal for use on tactical rigs due to minimal width
- Vertical and horizontal belt slots
- Also available in tactical mounting configuration



79* // SLIMLINE OPEN TOP DOUBLE MAGAZINE POUCH

- Magazines are oriented "bullets out" to save space on duty belt
- Optimal use on tactical rigs due to minimal width
- Vertical belt slots
- Also available in tactical mounting configuration



777* // SLIMLINE TRIPLE MAGAZINE POUCH

- Magazines are oriented "bullets out" to save space on belt
- Optimal for use on tactical rigs due to minimal width
- Vertical and horizontal belt slots
- Also available in tactical mounting configuration



775* // SLIMLINE OPEN TOP TRIPLE MAGAZINE POUCH

- Adjustable angle positions designed into belt loop
- Designed to carry two handgun magazines and one pair of handcuffs
- Adjustable tension device to help retain magazines in pouch
- Also available in tactical mounting configuration



DUTY ACCESSORIES

3094*

// COMPACT LIGHT HOLDER

- Detent around flashlight bezel creates security upon holstering
- Adjustable dual tension device holds light as secure as desired
- Comes standard with 744BL Belt Clip offering an adjustable cant
- Fits 1.5" (38mm) to 2.25" (58mm) belt widths



77*

// SINGLE MAGAZINE POUCH

- Several sizes to fit most popular magazines
- Also available in tactical mounting configuration



72



73



74*



75*



76*



277*



307* Light



307* EDW



306*



308*



35*

135*

// BATON HOLDER

- Fits 16" (406cm), 21" (533cm) or 26" (660cm) expandable batons
- 26" length also fits Streamlight® Stinger® flashlight
- Available in two sizes for 1.5" and 2"-2.25" (38mm-58mm) belts



72

// DOUBLE MAGAZINE AND CUFF POUCH

- Adjustable angle positions designed into belt loop
- Adjustable tension device to help retain magazines in pouch

73

// OPEN TOP DOUBLE MAGAZINE POUCH

- Features adjustable angle positions for both vertical and horizontal carry
- Tension screw allows retention adjustment

74*

// HANDGUN/RIFLE COMBINATION MAGAZINE POUCH

- Designed to carry two handgun magazines and one rifle magazine
- Adjustable tension device to help retain magazine in pouch
- Optimal for duty officers with carbine or rifle within vehicle

75*

// OPEN TOP DOUBLE MAGAZINE POUCH

- Span between pouches plus low cut allow for a quick and easy draw
- Tension screw allows retention adjustment

76*

// SINGLE MAGAZINE POUCH

- Several sizes to fit most popular magazines
- Also available in tactical mounting configuration

277*

// QUAD MAGAZINE POUCH

- Designed with space for up to four 1911-style magazines; also offered in 10-round versions
- Center divider retains extra magazine while fixed magazine is in use
- Vertical or horizontal belt slots for standard or low profile positions

307*

// LIGHT/EDW CARTRIDGE HOLDERS

- Pouch fits most popular gun mounted lights
- Also designed for the Taser® cartridge
- Fits 2" to 2.25" (50mm-58mm) belt widths
- Also available in tactical mounting configuration

306*

// OPEN TOP MINI-FLASHLIGHT HOLDER

- Half-sheath style fully protects selected mini flashlights

308*

// HAND-HELD FLASHLIGHT HOLDER

- Flap closure style to fit select hand-held lights
- Also available in tactical mounting configuration

35*

// BATON HOLDER

- Extended baton can be reholstered
- Fits 16" (406cm), 21" (533cm) or 26" (660cm) expandable batons
- Also available in tactical mounting configuration

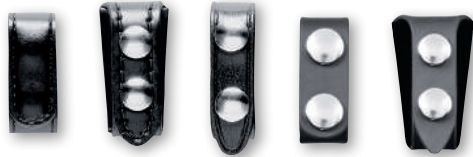

62 63 65 66 68



654 655
HK-11



67/67S 168 169S 170

Does Not
Include Key



62 // BELT KEEPER

- Slot fits up to 1.75" (45mm) belts
- Hidden snap

63 // SLOTTED BELT KEEPER

- Slotted, two-snap belt keeper
- Slot fits up to 1.75" (45mm) belt widths

65 // BELT KEEPER

- Standard 0.75" (19mm) belt keeper
- Available in two sizes for 2" and 2.25" (50mm-58mm) belts

66 // VALUE KEEPER 2.25"

- Injection-molded design
- Standard 0.75" (19mm) belt keeper
- Slots fit 2.25" (58mm) belt widths

68 // SLOTTED VALUE KEEPER

- Injection-molded design
- Slot fits up to 1.75" (45mm) belt widths

654 // SLOTTED BELT KEEPER

- Slot fits up to 1.75" (45mm) belt widths
- 4-snap closure

655 // HEAVY DUTY BELT KEEPER

- Rugged, heavy-duty, two-snap belt keeper
- Extra wide at 1.25" (32mm)

HK-11 // HIDE-A KEYPER™

- Hidden handcuff key on inside of belt keeper

67/67S // BATON RING

- Also fits C-cell flashlights
- 67 (not shown) is without snap

168 // KEY RING (DOES NOT INCLUDE KEY)

- Heavy-duty metal spring hook
- Protective flap
- 2-snap design

169S // KEY RING

- Heavy-duty metal spring hook
- 1-snap design

170 // SILENT KEY HOLDER

- SafariLaminate™ construction
- Hook and loop adjustable pouch

DUTY ACCESSORIES



38-8*

// IMPACT ROUND CASE, TOP FLAP

- Closed top pouch for 37/40mm less lethal rounds
- Designed for the Defense Technology® eXact iMPact™ and Direct Impact® rounds
- Can be ordered for 2.25" (58mm) belt
- Also available in tactical mounting configuration



37-8*



692S



730



37*



38*



090



90



190*



290



690



764



768



33*

37-8*

// OPEN TOP IMPACT ROUND HOLDER

- Open-top pouch for 37/40mm less lethal rounds
- Can be ordered for 2.25" (58mm) belt slide or mount on leg and vest accessory
- Also available in tactical mounting configuration

692S

// BATON RING WITH SNAP

- For side-handle batons
- Snaps/slides on duty belt

730

// HEAVY DUTY FLASHLIGHT RING

- Features a shatter-resistant nylon ring
- 1-snap closure
- For D-cell and C-cell flashlights

37*

// OPEN TOP MACE®/OC SPRAY HOLDER

- Open-top for quick access
- Also available in tactical mounting configuration

38*

// MACE®/OC HOLDER

- Top flap for added security
- Also available in tactical mounting configuration

090

// OPEN TOP HANDCUFF CASE

- Open-top thermoformed design
- Fits chain or hinged cuffs

90/90H

// HANDCUFF CASE

- Specify chain or hinged cuffs

190*/190H*

// HANDCUFF CASE

- Specify chain (190) or hinged (190H)
- Also available in tactical mounting configuration

290/290H

// DOUBLE HANDCUFF CASE

- Specify chain or hinged cuffs
- 290H (not shown) fits hinged cuffs

690

// HANDCUFF STRAP

- Saves space on duty belt
- 1-snap design

764

// RECORDER CASE

- Features a protective pouch and an adjustable bungee cord tie-down with a snap closure

768

// COMPACT SPARE CUFF™ HOLDER

- Metal clip attachment to fit 2" to 2.25" (50mm-58mm) duty belt

33*

// SURGICAL GLOVE HOLDER

- Hook and loop closure
- Holds one or three pair of surgical gloves; please specify



761*

762*

763

766

BACK

761*

// ADJUSTABLE RADIO HOLDER

- Adjustable bungee cord tie-down with a snap closure
- Fits most standard portable police radios

762*

// RADIO HOLDER WITH SWIVEL

- Features a detachable swivel belt loop for easy retrieval
- Protective pouch and adjustable bungee cord tie-down with a snap closure

763

// UNIVERSAL RADIO HOLDER – PORTABLE

- Universal fit
- Features an adjustable band to fit almost any standard portable police radio
- Bottom lip prevents the radio from falling through

766

// RADIO HOLDER

- Adjustable bungee cord tie-down with snap closure
- Utilizes 745BL Belt Attachment – giving users the ability to clip on or off of the belt without removing other accessories
- Fits belt widths from 1.5" (38mm) to 2.25" (58mm)



080-12

081-12

CD-2

080-12

// SHOTGUN SHELL HOLDER

- Molded shotgun shell holder holds two 12-gauge shells
- Belt clip features an extended bottom hook for security

081-12

// SHOTGUN SHELL HOLDER

- Molded shotgun shell holder holds two 12-gauge shells
- Includes mounting holes



371

340

CD-2

// SPEEDLOADER HOLDER

- Strong, epoxy-coated steel clips
- Lined with a vinyl pad insert to ensure loader stability
- CD-2 clips firmly onto any belt up to 2" (50mm) wide
- Metal construction

371

// SINGLE SPEEDLOADER HOLDER

- Ultra-low profile and quick, easy single-action draw – providing the fastest "top-flap" speedloader holder available
- Design carries cartridges on either side of the belt
- Allows user to grip both sides of the loader while unsnapping the top flap
- Fits 1.75" (45mm) belts

340

// DOUBLE SPEEDLOADER HOLDER

- Standard double speedloader
- Chrome or brass snap



TACTICAL & MILITARY

Safariland® tactical gear is a breed apart. Safariland products are battle-proven worldwide and offer an unmatched combination of quality, functionality and versatility in every product that carries our name. From leg-drop holsters and MOLLE-compatible attachment systems, to munitions carriers and more, Safariland gives you the tactical advantage you need to carry the day – day in and day out.

- All tactical holster models feature a double strap leg shroud with mounting holster for optional accessories
- All holsters available in STX Tactical® finishes (all colors) unless noted

STX TACTICAL® COLORS AVAILABLE



ALL HOLSTERS ON THIS PAGE ARE 7TS™

7TS™ COLORS AVAILABLE

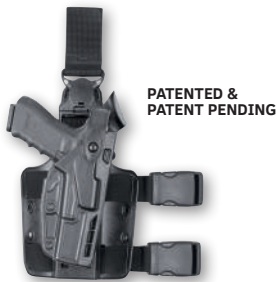

PATENTED & PATENT PENDING

7305
// 7TS™ ALS® TACTICAL HOLSTER WITH QUICK-RELEASE LEG STRAP



PATENTED & PATENT PENDING

7304
// 7TS™ ALS® TACTICAL HOLSTER

- ALS® (Automatic Locking System) secures weapon once holstered; simple straight up draw once release is deactivated
- SLS (Self Locking System) Rotating Hood
- Optional Sentry
- Constructed of SafariSeven™, a proprietary nylon blend that is completely non-abrasive to a firearm's finish
- Raised stand-off surfaces in holster's interior creates air space around the weapon allowing dirt and moisture to quickly clear any contact with the firearm
- Very high heat and low cold tolerances; structurally sound from 300° F to -50°F
- Available in SafariSeven™ Plain Black and FDE Brown finishes



PATENT PENDING

7004
// 7TS™ SLS TACTICAL HOLSTER

- SLS (Self Locking System) Rotating Hood
- Optional Sentry
- Constructed of SafariSeven™, a proprietary nylon blend that is completely non-abrasive to a firearm's finish
- Raised stand-off surfaces in holster's interior creates air space around the weapon allowing dirt and moisture to quickly clear any contact with the firearm
- Very high heat and low cold tolerances; structurally sound from 300° F to -50° F
- Available in SafariSeven™ Plain Black and FDE Brown finishes



7005
// 7TS™ SLS TACTICAL HOLSTER WITH QUICK-RELEASE LEG STRAP

7TS™



PATENTED & PATENT PENDING

7355

// 7TS™ ALS® TACTICAL HOLSTER WITH QUICK-RELEASE LEG STRAP



PATENTED & PATENT PENDING

7354

// 7TS™ ALS® TACTICAL HOLSTER

- ALS® (Automatic Locking System) secures weapon once holstered, simple straight up draw once release is deactivated
- Open-top design without SLS for quick retrieval of weapon
- Constructed of SafariSeven™, a proprietary nylon blend that is completely non-abrasive to a firearm's finish
- Raised stand-off surfaces in holster's interior creates air space around the weapon allowing dirt and moisture to quickly clear any contact with the firearm
- Very high heat and low cold tolerances; structurally sound from 300° F to -50° F
- Available in SafariSeven™ Plain Black and FDE Brown finishes
- Also optimized for MOLLE vest use (OMV version), Models 7384 and 7385



PATENTED

ALS

automatic locking system

6354DO

// ALS® OPTIC TACTICAL HOLSTER

- ALS® (Automatic Locking System) secures weapon once holstered; simple straight up draw once release is deactivated
- For use with red dot optic-equipped weapons
- Cordura® nylon wrap finish reduces Infrared (IR) Signature
- SafariLaminate™ thermal-molded construction protects handgun and sights
- Suede lined to protect handgun's finish
- Available for Glock 17, 22, 34 & 35 weapons with and without light
- Available in MultiCam®, Ranger Green, Coyote, Khaki and Black finishes
- Available in 6354DOH with protective flip top for RDS

6004USN

// LOW SIGNATURE SLS TACTICAL HOLSTER

- Features the SLS (Self Locking System) rotating hood system
- SLS allows for a smoother, single-motion draw
- Genuine SafariLaminate™ construction with suede lining to help protect the weapon's finish
- Cordura® nylon wrap finish reduces Infrared (IR) Signature
- Available in MultiCam®, Ranger Green, Coyote, Khaki and Black finishes





6004
// SLS TACTICAL HOLSTER

- Features the SLS (Self Locking System) rotating hood system allowing for a smoother, single-motion draw and greater protection against attempted weapon takeaways
- Hood Guard is standard; optional Sentry available
- Suede lined to protect handgun's finish



Shown here with optional Double Magazine Pouch mounted

6005
// SLS TACTICAL HOLSTER WITH QUICK-RELEASE LEG STRAP



ALS
automatic locking system

6304
// ALS®/SLS TACTICAL HOLSTER

- ALS® (Automatic Locking System) secures weapon once holstered
- SLS allows for a smoother, single motion draw and greater protection against attempted weapon takeaways
- Hood Guard is standard; optional Sentry available
- Simple straight up draw once all releases are deactivated
- Suede lined to protect handgun's finish

PATENTED



6305 PATENTED
// ALS®/SLS TACTICAL HOLSTER WITH QUICK-RELEASE LEG STRAP



ALS
automatic locking system

6354
// ALS® TACTICAL HOLSTER

- ALS® (Automatic Locking System) secures weapon once holstered; simple straight up draw once release is deactivated
- Open-top design without SLS for quick retrieval of weapon
- Suede lined to protect handgun's finish

PATENTED



6355 PATENTED
// ALS® TACTICAL HOLSTER WITH QUICK-RELEASE LEG STRAP



6034
// SLS AMBIDEXTROUS MILITARY TACTICAL HOLSTER

- Features the SLS (Self Locking System) rotating hood system allowing for a smoother, single-motion draw and greater protection against attempted weapon takeaways
- Ambidextrous body design
- Designed to accommodate the Beretta M9/92F or Sig P226 pistol with or without a light or LAM unit
- Hood Guard is standard; optional Sentry available
- Also available with on Mid-ride UBL (6230) or Low-ride UBL (6235)



6035
// SLS MILITARY TACTICAL HOLSTER



PATENTED



6384 // ALS® OMV TACTICAL HOLSTER

- ALS® (Automatic Locking System) secures weapon once holstered; simple straight up draw once release is deactivated
- Holster is optimized for MOLLE vest use (OMV), with lower center of gravity than most other Safariland® duty and tactical holsters for less pulling on vest
- Open-top design without SLS for quick retrieval of weapon
- Hood Guard is standard; optional ALS Guard available
- Suede lined to protect handgun's finish

6384 Holster with
MLS 15 on Vest



6385 // ALS® OMV TACTICAL HOLSTER WITH QUICK-RELEASE LEG STRAP

- Adjustable vertical leg strap with quick release detachable leg harness

ALS® MILITARY KIT

- ALS® (Automatic Locking System) secures weapon once holstered, simple straight up draw once release is deactivated
- Open-top design without SLS for quick retrieval of weapon
- Single strap leg shroud with Quick Locking Receiver Plate (QLS 22) and a 568BL Paddle.
- 567BL Injection Molded Belt Loop with a Quick Locking Receiver Plate (QLS 22). The 567BL can be modified to fit 1.5", 1.75", 2", and 2.25" belt slot with a 1" drop
- Adjustable shoulder harness with Quick Locking Receiver Plate (QLS 22).
- MOLLE Locking Fork (MLS16) with Quick Locking Receiver Plate (QLS 22) mount included for MOLLE chest carry



PATENT PENDING



PATENTED



6378USN // ALS® LOW SIGNATURE HOLSTER

- ALS® (Automatic Locking System) secures weapon once holstered, simple straight up draw once release is deactivated
- Reduces Infrared (IR) Signature
- Compact profile for minimal interference with other equipment
- Optional ALS Guard (Model 6006) available for increased security
- Available in MultiCam®, Ranger Green, Coyote, or Khaki finishes
- Available for Beretta M9/M9A1/92F, Glock 19/23, and Sig Sauer P226



749 // ULTRA LOW-PROFILE HOLSTER

- Ultra low-profile design for MOLLE vest carry
- Secure attachment to front of vest for minimal movement and increased concealability
- Designed to be completely stable even under harsh conditions and violent movement, including off-road biking and airborne jumps
- Detent in trigger area for increased security
- Snap closure around MOLLE loops



LEG SHROUDS & ACCESSORIES

All leg shrouds and accessories are available in Black, Foliage Green, OD Green, FDE Brown, or Coyote Brown finishes.

36 // OC HOLDER

- Made specifically to hold the MK-9 series of aerosols
- Open-top design for quick retrieval yet sturdy product retention

34 // OC HOLDER

- Made specifically to hold the Defense Technology® Instantaneous Blast
- Open-top design for quick retrieval yet sturdy product retention

085 // SHOTGUN SHELL HOLDER

SEE MORE ON PAGE 102

ALL TACTICAL ACCESSORIES ON THIS PAGE CAN BE ORDERED WITH THE MLS 16 OR ELS 34 LOCKING FORK ALREADY ATTACHED.

6005-6 // STANDARD DOUBLE LEG SHROUD WITH QUICK-RELEASE STRAP

- Features harness and shroud to mount holsters and accessories
- Leg shroud features silicon strap for non-slip traction
- Ambidextrous



6005-6 shown here with accessories attached

6004-10 // SINGLE STRAP LEG SHROUD

- Lower profile leg shroud
- Can mount accessories on both sides of holster or used for 3 accessories
- Adjustable vertical leg strap to adjust ride height



6004-10 shown here with accessories attached

774 // RIFLE MAG POUCH

SEE MORE ON PAGE 82

40 // DISTRACTION DEVICE® HOLDER

- Fits several Defense Technology® Distraction Device® models

37-8 // OPEN TOP IMPACT ROUND HOLDER

- Belt slide or mount on leg and vest accessory

SEE MORE ON PAGE 74



37 // OPEN TOP IMPACT ROUND HOLDER

SEE MORE ON PAGE 74

76 // SINGLE MAG POUCH

SEE MORE ON PAGE 72

78 // SLIMLINE DOUBLE MAGAZINE POUCH

SEE MORE ON PAGE 71

6004-6 shown here with accessories attached

6004-6 // STANDARD DOUBLE LEG SHROUD

- Features harness and shroud to mount holsters and accessories
- Ambidextrous



6009-110

// SINGLE STRAP LEG SHROUD WITH D-RING

- Utilizes a unique D-Ring on the strap for increased leg flexibility
- Single leg strap design
- Minimally-sized leg shroud for decreased footprint on the thigh



6005-10

// SINGLE STRAP LEG SHROUD WITH QUICK-RELEASE

- Features harness and shroud only to mount accessories and holsters
- Leg straps feature silicone strips for non-slip traction
- Ambidextrous



6004-27

// DROP FLEX ADAPTER ON SINGLE LEG SHROUD W/ QLS 22

- Allows user to wear a thigh rig higher on the leg with more stability, eliminating leg shroud movement
- Sits low enough for use with body armor and in vehicles, while also providing two mounting points for accessories
- Includes QLS 22 Receiver Plate (can also be ordered with MLS Receiver Plate or plain)
- Fits belt widths up to 2.25" (58mm)
- Available in Black, Foliage Green or, FDE Brown, or Coyote Brown finishes



Shown here with 568BL Paddle and 6004-10 Single Strap Leg Shroud

6004UFA-6

// UNIVERSAL FLEX ADAPTER

- Allows user to wear a thigh rig below the hip without shifting weight farther down the leg
- Hole pattern on UFA makes connecting to various mounts possible including 568BL Paddle, ELS Fork, QLS Fork or 745BL Belt Clip
- For use in conjunction with 6004-10 Leg Shroud



6009VE

// D-RING STRAP WITH ENHANCED HOOK & LOOP BELT ATTACHMENT



6009VE

6005VE

// QUICK-RELEASE BUCKLE WITH ENHANCED HOOK & LOOP BELT ATTACHMENT



6005VE

- Fits Safariland® tactical leg shrouds
- Belt attachment portion can be detached when not needed
- Secondary hook and loop flap ensures continuous attachment to belt when in use
- 6009VE model provides easy lateral movement

6009-11

// D-RING STRAP

- Provides easy lateral movement
- Fits all Safariland® tactical shrouds



6004-11

// LEG STRAP ONLY

- Fits tactical holster systems
- Replacement strap for standard tactical rigs



LEG SHROUDS & ACCESSORIES



6005-23

// MLS ACCESSORY FORKS ON QUICK-RELEASE STRAP

- Allows mounting of any tactical holster with quick-release leg strap directly to the MOLLE loops on the side of a vest or MOLLE web belt
- Enables user to forgo wearing a belt and put the weight onto a load-bearing vest and thigh rig
- Ideal for combining with a tactical vest without having to make any changes to a duty belt to be ready as a first responder



6009-23

// MLS ACCESSORY FORK ON D-RING

- Allows mounting of any tactical holster with D-Ring strap directly to the MOLLE loops on the side of a vest or MOLLE web belt
- Enables user to forgo wearing a belt and put the weight onto a load-bearing vest and thigh rig



4145

// MUNITIONS BUTT STOCK CADDY

- For 37/40mm impact rounds and 12-gauge rounds
- Elastic straps to fit many butt stocks
- Holds (3) 40mm or (5) 12-gauge rounds



NEW

PRA

// PICATINNY RAIL ADAPTER

- Allows the placement of any 2-hole pattern Safariland® tactical or competition accessory onto Picatinny rail systems



NEW

MSA

// MOLLE SLIDING ADAPTER

- Compatible with Model 71 Tactical Universal Magazine Pouch
- Easily slides and locks into MOLLE webbing; removable in seconds
- Minimal space used on MOLLE vests
- Permits multiple pouches lined up side to side



4555

// SHOOTERS' RANGE BAG

- Removable center carry compartment has zippered, padded side panels for 4 separate handgun compartments
- Adjustable hook and loop dividers to personalize accessory space
- Magazine pouches conveniently sewn into main storage area
- Two large exterior pockets, two large end pockets with flap closure and a fully lined interior
- Full-wrap carry handles make it easy to move gear to different shooting stations
- Outer carry bag has dual zipper top for easy access and full coverage, flat side zipper pocket, ID window, and large outside zippered pocket for towel, shooting glasses or hearing protection
- Overall dimensions: 14" x 9" x 10"



774

// RIFLE MAG POUCH

- Clip-on belt attachment to fit 1.5" (38mm) to 2.25" (58mm) belts
- Adjustable for carry angle
- SafariLaminate™ thermal-molded construction with tension device
- Ambidextrous
- Can be ordered with QAS Locking Forks attached
- Available in Black, Foliage Green or, FDE Brown, or Coyote Brown finishes

GUN CASES

Safariland® gun cases are feature-laden and made from rugged ballistic pack cloth and are offered in black only unless otherwise specified



4553

// PREMIUM DUAL HANDGUN CASE

- Full interior closed-cell foam surrounded by soft lining for safe handgun storage
- Four outside magazine/accessory pouches
- Dual concealed pockets to individually protect handgun
- 12" length to carry up to 6" handguns
- Wraparound handles



4552

// DUAL RIFLE CASE

- Heavy-duty lockable zippers, one adjustable outside covered accessory pouch
- Large dual handgun/accessory pouch with individual hook and loop enclosed handgun areas
- Closed-cell protective foam padding and 2-in. perimeter lip
- Assorted accessory pockets inside case
- Adjustable padded shoulder harness for shoulder carry
- Includes adjustable backpack-style carry straps that tuck away in storage pocket when not in use
- Available in Black or Tan and in 36" or 46" lengths



4556

// 3-GUN COMPETITION CASE

- Heavy-duty lockable zippers, two adjustable outside accessory pouches
- Large dual handgun/accessory pouch with individual hook and loop enclosed handgun storage areas and 4 pistol mag pouches large enough for extended magazines
- Closed-cell protective foam padding and 2-in. perimeter lip
- Assorted accessory pockets inside case
- Adjustable padded shoulder harness for shoulder carry
- Includes adjustable backpack-style carry straps that tuck away in storage pocket when not in use
- Unique zippered barrel expansion slot on side of case can be opened to allow use of longer firearms (up to 51")
- 46" overall length (with expansion slot closed)



QUICK ATTACHMENT SYSTEMS

Safariland® Quick Attachment Systems, consisting of the QLS, ELS and MLS represent the coming together of technology with the requirement for modular and versatile products. Originally designed for the military to quickly transfer the holster from the leg to the vest, the QAS family has now gone beyond strictly military functions to include law enforcement, concealed carry, and sporting applications. Whether the scenario facing you involves the need to adjust holster location to conserve space while boarding an APC or to quickly switch out magazine types before the latest 3-Gun match, the QAS family of products will help accomplish your goals.

MLS (MOLLE LOCKING SYSTEM)

- Provides a holster or accessory with a quick, easy, and secure attachment to any MOLLE loop-equipped apparel
- Allows for quick removal and installation between attachment points such as the MOLLE vest, belt loop, and/or tactical leg shroud
- Allows many types of Safariland® holsters and accessories to be mounted at various orientations and angles to suit the needs and preferences of the individual user
- Operator can rearrange gear quickly and easily without the use of tools
- Allows holstered weapons and accessories to be removed without removing apparel, such as vest, leg shroud, or belt
- Mount almost any holster or accessory in the right position for any mission



MLS16

1. MLS 16 ACCESSORY LOCKING FORK

- Threads directly through MOLLE lops to mount pouches, or into the back of the QLS 22 or ELS 35 for attachment of pouches and holsters to vests
- Colors: Black, Foliage Green, OD Green, FDE Brown, or Coyote Brown finishes



ELS (EQUIPMENT LOCKING SYSTEM)

- Provides a mounting platform for any tactical and competition accessories to be placed in various locations, including belt clips and tactical rigs or directly on MOLLE loops with the use of an MLS 16 Locking Fork
- Fork attaches to any tactical or competition accessory, including the 774 Rifle Mag Pouch, 78 Slimline Dual Magazine Pouch, and Impact Round cases
- Receiver plate mounts to any thigh rig, 744BL belt clip or MLS 16 fork (for use of ELS on MOLLE loops), or can be attached directly to the pre-cut mounting holes on any QAS belt
- A quick pinch of the thumb and index finger allows the removal of any product attached to the fork unit for attachment on any other ELS 35 location
- May be purchased with or placed directly onto the 744BL belt clip for convenient waistline location
- Useful in quickly switching out accessories while maintaining the same root product, whether it be a belt, thigh rig or magazine pouches for a competition event, etc.
- Very small receiver footprint (1 7/8" W x 2 3/4" H)

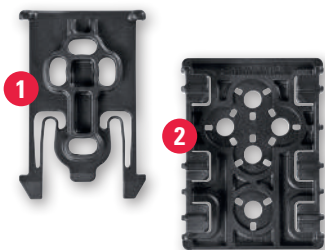

ELS 34 & 35

1. ELS 34 EQUIPMENT LOCKING FORK

- Mounts to any tactical accessory, then connects to the ELS 35 Receiver Plate
- Colors: Black, Foliage Green, OD Green, FDE Brown, or Coyote Brown finishes

2. ELS 35 EQUIPMENT RECEIVER PLATE

- Mount platform for tactical thigh rig or any other two-hole accessory location
- Colors: Black, Foliage Green, OD Green, FDE Brown, or Coyote Brown finishes



QUICK ATTACHMENT SYSTEMS

QLS (QUICK LOCKING SYSTEM)

- The QLS provides officers the ability to easily and quickly remove and secure their weapon without having to remove weapon from holster. Especially effective in correctional institutions and courthouse appearances
- Also effective for concealed carry in ease of transferring gun from body to other mounting point, such as vehicle
- Mount almost any Safariland® duty holster on an equipment belt with use of the Safariland UBL
- Provides a highly versatile holster system with a quick, easy and secure attachment to a variety of locations – belt, thigh rig, furniture, or vehicle, etc. Can also be used with the Safariland MLS 16 Accessory Locking Fork for attachment to MOLLE vests
- QLS System passes Level I Retention™ pull test

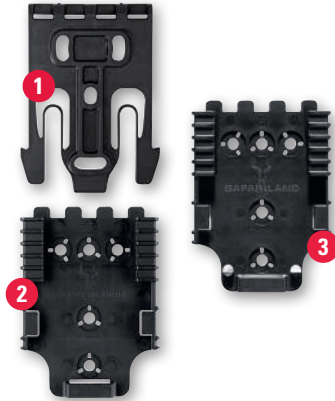

QLS 19 & 22

// FOR DUTY USE – PASSES LEVEL I RETENTION™ TEST

1. QLS 19 DUTY HOLSTER LOCKING FORK

- Mounts directly to the back of any three-hole pattern holsters, then connects to the QLS 22 Receiver Plate
- Colors: Black, Foliage Green, OD Green, FDE Brown, or Coyote Brown finishes

2. QLS 22 DUTY RECEIVER PLATE

- Mounting platform for the QLS 19 Duty Locking Fork. Attaches directly to Universal Belt Loop (UBL), thigh rig or other mounting platforms
- Colors: Black, Foliage Green, OD Green, FDE Brown, or Coyote Brown finishes

3. QLS 22L DUTY RECEIVER PLATE

- Same as the QLS 22 with an extra locking feature



QAS BELTS

// FOR MORE INFORMATION PLEASE SEE CORRESPONDING PAGE



4332

// ELS TACTICAL BELT 2" (50mm)

SEE MORE ON PAGE 69



832

// QAS DUTY BELT 2.25" (58mm)

SEE MORE ON PAGE 69



032

// ELS COMPETITION BELT 1.75" (45mm)

SEE MORE ON PAGE 101



QLS (QUICK LOCKING SYSTEM)

DUTY/TACTICAL



QLS ON A DUTY BELT

1. QLS 22 W/ UBL ON BELT
2. QLS 19 ON HOLSTER BACK
3. QLS 22 W/ UBL W/ QLS 19 ON HOLSTER

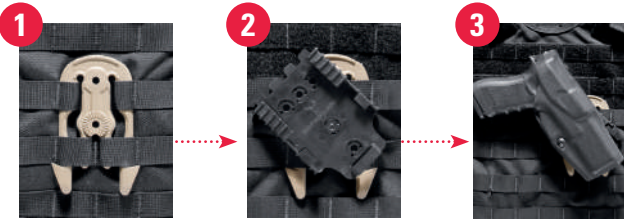

QLS ON A MOLLE VEST

1. MLS 16 ON VEST
2. QLS 22 W/ MLS 16 ON VEST
3. QLS 22 ON MLS 16 W/ QLS 19 ON HOLSTER

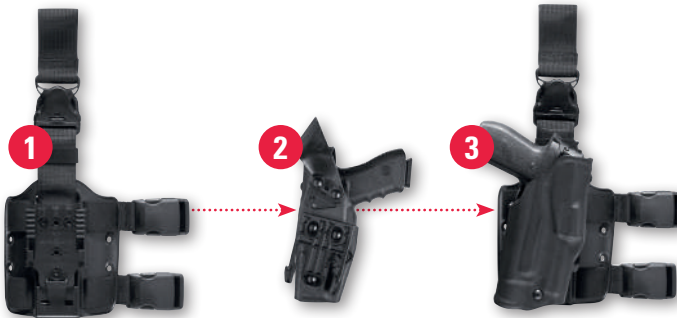

QLS ON A THIGH RIG

1. ATTACH QLS 22 TO THIGH RIG
2. ATTACH QLS 19 TO BACK OF HOLSTER
3. QLS 22 ON SHROUD W/ QLS 19 HOLSTER

CONCEALMENT/ PERSONAL PROTECTION



QLS IN VEHICLE

1. QLS 22 ON PADDLE W/ QLS 19 ON HOLSTER
2. REMOVING HOLSTER FROM QLS 22
3. TRANSFERRING HOLSTER TO QLS 22 MOUNTED IN VEHICLE



QLS AT HOME

1. QLS 22 ATTACHED TO DRESSER
2. QLS 22 ON DRESSER W/ QLS 19 ON HOLSTER



QLS AT HOME

1. QLS 22 ON SAFE WALL
2. QLS 22 ON SAFE WALL W/ QLS 19 ON HOLSTER

MLS (MOLLE LOCKING SYSTEM)

TACTICAL



MLS ON A VEST

1. HOLSTER W/ MLS 15 THREADED DIRECTLY THROUGH MOLLE LOOPS



6004-24

// MLS ACCESSORY FORK ON SMALL MOLLE PLATE

- A mount with the MLS 16 Accessory Fork already affixed; attaches to existing MOLLE pouches, then is easily threaded directly through MOLLE loops
- Can also be attached to an MLS 17 or MLS 18 Receiver Plate, then mounted on a MOLLE vest, thigh rig, belt, or other attachment point

TACTICAL



ELS ON A LEG SHROUD

1. (2) ELS 35s ON LEG SHROUD
2. ELS 34 W/ RIFLE MAG POUCH & ELS 34 W/ PISTOL MAG POUCH
3. (2) ELS 35s ON LEG SHROUD W/ (2) ELS 34s ON RIFLE & PISTOL MAG POUCH



ELS ON A TACTICAL BELT

1. 4332 ELS TACTICAL BELT
2. ELS 34 W/ RIFLE MAG POUCH
3. ELS 34 W/ 40MM GRENADE HOLDER
4. 4332 BELT W/ (3) ELS 35 RECEIVER PLATES AND READY TO MOUNT ACCESSORIES WITH ELS FORKS

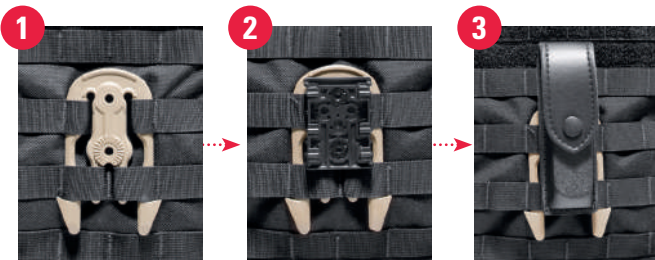

ELS ON MOLLE VEST

1. MLS 16 ON VEST
2. ELS 35 W/ MLS 16 ON VEST
3. ELS 34 W/ MAG POUCH W/ ELS 35 ON MLS 16 ON VEST

COMPETITION

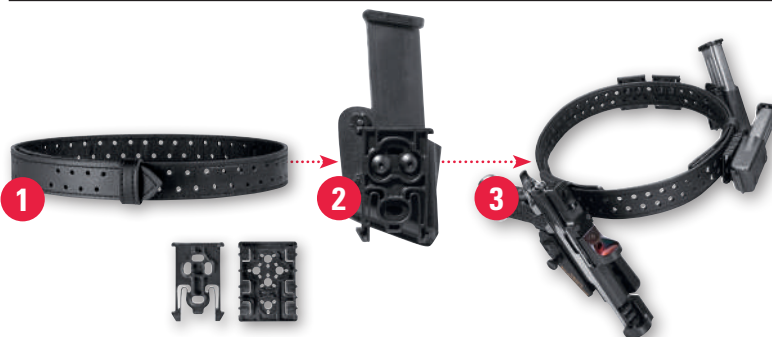

ELS ON A COMPETITION BELT

1. 032 BELT W/ ELS 34 & ELS 35
2. ELS 34 ON MAG POUCH
3. 032 ELS COMPETITION BELT FULLY RIGGED W/ HOLSTER,
(4) ELS 35s & (2) 773 MAG POUCHES W/ ELS 34s



6005-23

// MLS ACCESSORY FORK ON QUICK RELEASE HARNESS

- Allows mounting of any tactical holster with quick-release leg strap directly into the MOLLE loops on the side of a vest or MOLLE web belt
- Enables user to forgo wearing a belt and put the weight onto a load-bearing vest and thigh rig



6009-23

// MLS ACCESSORY FORK ON D-RING

- Allows mounting of any tactical holster with D-Ring strap directly to the MOLLE loops on the side of a vest or MOLLE web belt
- Enables user to forgo wearing a belt and put the weight onto a load-bearing vest and thigh rig

QAS KITS

Kit	Contents
QUICK-KIT 1	(1) QLS 19, (1) QLS 22
QUICK-KIT 2	(1) QLS 19, (1) QLS 22L
QUICK-KIT 3	(1) QLS 19, (2) QLS 22
QUICK-KIT 4	(1) QLS 19, (2) QLS 22L
ELS-KIT 1	(2) ELS 34, (2) ELS 35

*ALL KITS INCLUDE MOUNTING HARDWARE

LIGHT SYSTEMS

Safariland® brings innovative designs to today's light systems. The popular Rapid Light System (RLS™) offers a quality hand-held light and a weapon-mounted light all in one. The new Individual Light System (ILS™) features a distinctive tailcap that allows for instantly switching from low to high light.



RLS™ Rapid Light System
// RLS

1. Ambidextrous.
2. Super-bright LED technology (190 lumens) – bright enough to be your primary light. Prism Reflector System penetrates light up to 350 feet.
3. Uses 3 AAA batteries – no expensive proprietary batteries needed.
4. Integral clip for easy securement to belt or garment – no dedicated light mount holster required.
5. Fits most handgun models that incorporate an integral rail system – also mounts to rifles and shotguns that have a Picatinny rail.
6. Quickly transitions from standard flashlight to tactical illumination.
7. Can be operated with either thumb, or change to other side to operate with trigger finger. Push button provides controllable on/off illumination of target to minimize loss of handgrip, sight picture and exposure.
8. RLS™ mount will accommodate most hand-held compact lights in the range of .970 (24.6mm)- 1.060 (26.9mm) in diameter.

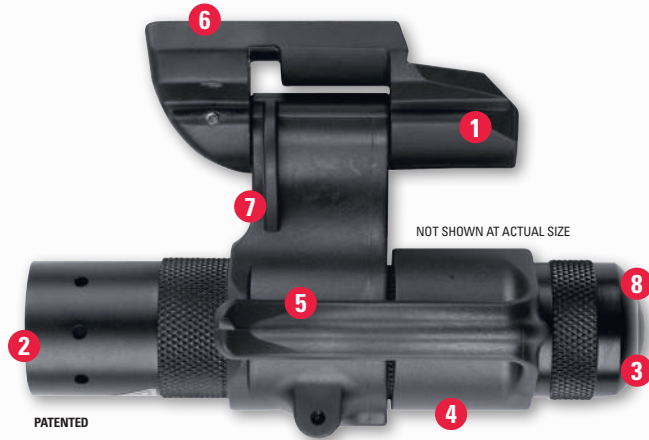

Easily and securely attaches to waistband or belt with integral clip



Push-button illumination



3 AAAs provide over 40 hours' use



RLSP // RLS LIGHT WITH PRESSURE SWITCH

- RLS™ Light System with tape pressure switch
- Eight inch cord for versatile positioning
- Pressure switch split for low 10 lumens or high 190 lumens



ILS-1 // INDIVIDUAL LIGHT SYSTEM

- Super-bright LED technology
- Features both a low and high light settings (peripheral buttons 10 lumens main button 190 lumens)
- Uses 3 AAA batteries (included) – no expensive proprietary batteries needed
- Integral clip for easy attachment to belt or garment
- Peripheral Buttons: 10 Lumens
- Main Button: 190 Lumens (ILS-1)



ILS-2 // INDIVIDUAL LIGHT SYSTEM

- Over 450 lumens on highest setting with 75 minute runtime
- Dual button tailcap design to instantly switch from 15 to 450 lumens without thumbing through a multi-stage pressure pad
- 6 AAA batteries provide power, difficult to find lithium batteries not needed
- Removable bezel design for scalloped or flat flashlight face
- Compatible with RLS mount
- Pocket clip for easy carry



RRL // ROGERS' RAIL LITE

- Ambidextrous design fits on any Picatinny/1913 rail
- Tail on/off switch is positioned right at shooters forward thumb
- Easy snap on and off installation
- Made of a heavy duty polymer yet is extremely light weight
- External rib design for added strength and grip
- Streamlight® Microstream® 28 lumen flashlight included

PATENT PENDING



RLSL // RLS™ LENS KIT

- Mounts onto the bezel of RLS™ light
- Red, blue, and green lenses included
- Can also be used with the ILS-1



RLSR // RLS™ REDUCTION SLEEVE

- Enables the RLS™ mounting system to be used with lights of both .90" and .80" diameters
- Slides inside RLS mount to easily accept narrower lights

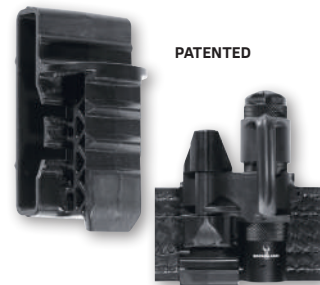

RLSM // MOUNT FOR DUTY BELT

- Provides a small mounting platform on duty belt to attach the RLS™ light
- Will also accommodate any light, laser, or other accessory that will fit on a Picatinny or light rail
- Fits belt widths up to 2.25" (58mm)
- Also fits on leg shroud, MLS or ELS Locking Fork
- Included with RLS

CONCEALMENT HOLSTERS

Whether needing a holster for deep concealment, long hours of wear, or for a reliable off-duty carry holster, Safariland® offers them all. Our holsters offer quality, performance and innovation in a variety of popular designs and finishes.

- All concealment holster models are available in 1.5" (38mm), 1.75" (45mm), 2" (50mm), or 2.25" (58mm) belt slots, unless noted otherwise.

BELT SLIDE



PATENT PENDING

GLS
grip locking system

5377

// **GLS™ CONCEALMENT BELT LOOP HOLSTER**

- GLS™ (Grip Lock System) secures weapon once holstered; retention is deactivated with the middle finger upon a standard shooting grip on the weapon
- SafariSuede™ lining helps remove dirt and oil while protecting the gun's finish
- Low-cut and compact design make concealment easy while also allowing for a quick draw
- Injection-molded belt loop is user adjustable for cant and can be worn cross draw
- Available in STX finishes



PATENTED

5379

// **WITH BELT CLIP**

- Features 745BL Belt Clip for easy attachment and detachment from belt
- Fits belt widths from 1.5" (38mm) to 2.25" (58mm)



NEW

537

// **GLS™ OPEN TOP CONCEALMENT BELT SLIDE HOLSTER**

- GLS™ (Grip Lock System) secures weapon once holstered; retention is deactivated with the middle finger upon a standard shooting grip on the weapon
- Soft, flexible holster body allows holster to mold around wearer
- Tension adjustment to customize tailor weapon fit to user preferences
- 1.5" Belt loops
- Available in Black, Flat Dark Earth, Olive Drab, and Foliage Green

PATENT PENDING



NEW

547

// **PRD™ OPEN TOP CONCEALMENT BELT SLIDE HOLSTER**

- Pinch Retention Device (PRD™) secures gun once it is fully seated in the holster by clamping onto both sides of the trigger guard; draw is initiated by pulling up through device
- Low profile design with wide weight disbursement for a comfortable carry and high concealability
- 1.5" belt loops
- Available in all STX Finishes

PATENTED

7TS

PATENTED &
PATENT PENDING



7367

// **7TS™ ALS® / SLS CONCEALMENT BELT SLIDE HOLSTER**

- ALS® (Automatic Locking System) secures weapon once holstered, simple straight up draw once release is deactivated
- SLS (Self Locking System) Rotating Hood; optional Sentry
- Injection-molded belt loop is user adjustable for cant and can be worn crossdraw
- Constructed of SafariSeven™, a proprietary nylon blend that is completely non-abrasive to a firearm's finish
- Raised stand-off surfaces in holster's interior creates air space around the weapon allowing dirt and moisture to quickly clear any contact with the firearm
- Very high heat and low cold tolerances structurally sound from 300° F to -50° F
- Available in SafariSeven™ Plain Black and FDE Brown finishes

CONCEALMENT HOLSTERS

ARMOR
COMMUNICATIONS
DUTY GEAR
BIKE
FIREARMS ACCESSORIES
LETHAL
PROTECTIVE GEAR
FORENSICS
PERFORMANCE APPAREL
ARMOR SYSTEMS
SURVIVABILITY SYSTEMS
TRAINING GROUP

7TS™

PATENTED & PATENT PENDING



PATENTED & PATENT PENDING

7377
// 7TS™ ALS® CONCEALMENT BELT SLIDE HOLSTER

- ALS® (Automatic Locking System) secures weapon once holstered, simple straight up draw once release is deactivated
- Open-top design without SLS for quick retrieval of weapon
- Constructed of SafariSeven™, a proprietary nylon blend that is completely non-abrasive to a firearm's finish
- Raised stand-off surfaces in holster's interior creates air space around the weapon allowing dirt and moisture to quickly clear any contact with the firearm
- Very high heat and low cold tolerances; structurally sound from 300° F to -50° F
- Injection-molded belt loop is user adjustable for cant and can be worn crossdraw
- Available in SafariSeven™ Plain Black and FDE Brown finishes

7379
// WITH BELT CLIP

- Features 745BL Belt Clip for easy attachment and detachment from belt
- Fits belt widths from 1.5" (38mm) to 2.25" (58mm) release is deactivated



PATENTED

ALS
automatic locking system

6377
// ALS® CONCEALMENT BELT SLIDE HOLSTER

- ALS® (Automatic Locking System) secures weapon once holstered; simple straight up draw once ALS is deactivated by thumb while obtaining shooting grip
- Injection-molded belt loop is user adjustable for cant and can be worn crossdraw
- Slim and low profile design for improved concealment
- Low-ride design for ease of draw
- Optional ALS® Guard available for increased security
- Available in STX finishes



PATENTED

6379
// WITH BELT CLIP

- Features 745BL Belt Clip for easy attachment and detachment from belt
- Fits belt widths from 1.5" (38mm) to 2.25" (58mm)



PATENTED

569
// WITH BELT CLIP

- Features 745BL Belt Clip for easy attachment and detachment from belt
- Fits belt widths from 1.5" (38mm) to 2.25" (58mm)



PATENTED

567
// CUSTOM FIT BELT LOOP HOLSTER

- 6 pistol and 4 revolver fits accommodate over 200 different weapons and are IDPA approved
- Belt loop is user-adjustable for cant angle; can also be worn cross draw
- Genuine SafariLaminate™ thermal-molded construction with suede lining to help protect the gun's finish
- Available in STX Plain Black finish

CONCEALMENT HOLSTERS

BELT SLIDE



5197 // RANGE SERIES OPEN TOP MID RIDE HOLSTER

- Adjustable belt loop eliminates common belt-bulging and does not interfere with draw
- Compact and lightweight with low cut sides for ease of draw
- Detent in trigger guard for reliable weapon security
- Belt loop is user adjustable for cant angle; can also be worn cross draw
- IDPA approved
- Available in 1.5" (38mm) and 1.75" (45mm) belt widths
- Available in STX finishes



PATENT PENDING

5199 // WITH BELT CLIP

- Features 745BL Belt Clip for easy attachment and detachment from belt
- Fits belt widths from 1.5" (38mm) to 2.25" (58mm)

5195 // RANGE SERIES OPEN TOP LOW RIDE HOLSTER

- Compact and lightweight
- Low cut sides for ease of draw
- Offset belt loop allows for a straight up draw
- Detent in trigger guard for added security
- Modular offset adapter accommodates the QLS19 locking fork, 745BL and 567BL
- IDPA approved; also recommended for female shooters
- Available in STX finishes



5195BL // RANGE SERIES LOW RIDE BELT LOOP



527 // OPEN TOP CONCEALMENT BELT SLIDE

- Low-profile, body-hugging design
- Features a molded detent that grips the trigger guard
- Genuine SafariLaminate™ thermal-molded construction
- Fits 1.75" (45mm) belt loop
- Available in Plain Black finish



6287 // SLS CONCEALMENT BELT LOOP HOLSTER

- Concealment version of the SLS holster
- Features a unique rotating hood design and semi-hi-ride position with slightly forward cant
- Rides close to the body, aiding in concealment and weapon retention
- Adjustable tension device
- Available in Plain Black or STX Tactical® finishes



PATENTED



6367 // ALS®/SLS BELT LOOP HOLSTER

- ALS® (Automatic Locking System) secures weapon once holstered; simple straight up draw once all releases are deactivated
- Includes SLS hood assembly and Hood Guard
- Optional Sentry available
- Available in Plain Black or STX Tactical® finishes



0701 // CONCEALMENT BELT SLIDE HOLSTER

- Features a dual retention system consisting of the trigger guard strap and an internal lock
- Mid-ride belt position and slight tilt forward for comfortable wear and smooth draw
- Tough outer layer adds further protection
- Available in STX Tactical® finish

CONCEALMENT HOLSTERS

PADDLE / BELT SLIDE

ARMOR
COMMUNICATIONS
DUTY GEAR
BIKE
FIREARMS ACCESSORIES
LETHAL
PROTECTIVE GEAR
FORENSICS
PERFORMANCE APPAREL
ARMOR SYSTEMS
SURVIVABILITY SYSTEMS
TRAINING GROUP



PATENT PENDING

GLS
grip locking system

5378 // GLS™ CONCEALMENT PADDLE & BELT LOOP COMBO

- GLS™ (Grip Lock System) secures weapon once holstered; retention is deactivated with the middle finger upon a standard shooting grip on the weapon
- SafariSuede™ lining helps remove dirt and oil while protecting the gun's finish
- Low-cut and compact design make concealment easy while also allowing for a quick draw
- Injection-molded paddle design is highly concealable and rides close to body
- Injection-molded belt loop is user adjustable for cant and can be worn cross draw
- Available in STX finishes



PATENT PENDING

NEW

5376 // HI-RIDE BELT SLIDE

- Rides 1" higher than standard belt slide
- Available in 1.5" (38mm) and 1.75" (45mm) belt widths



PATENTED & PATENT PENDING

NEW

7376 // HI-RIDE BELT SLIDE

- Rides 1" higher than standard belt slide
- Available in 1.5" (38mm) and 1.75" (45mm) belt widths



PATENTED & PATENT PENDING

7TS

7378 // 7TS™ ALS® CONCEALMENT PADDLE AND BELT LOOP COMBO

- ALS® (Automatic Locking System) secures weapon once holstered; simple straight up draw once release is deactivated
- Open-top design without SLS for quick retrieval of weapon
- Constructed of SafariSeven™, a proprietary nylon blend that is completely non-abrasive to a firearm's finish
- Raised stand-off surfaces in holster's interior creates air space around the weapon allowing dirt and moisture to quickly clear any contact with the firearm
- Very high heat and low cold tolerances; structurally sound from 300°F to -50° F
- Includes injection-molded belt loop; is user adjustable for cant and can be worn crossdraw
- Available in SafariSeven™ Plain Black and FDE Brown finishes



PATENTED

ALS
automatic locking system

6378 // ALS® CONCEALMENT PADDLE & BELT LOOP COMBO

- ALS® (Automatic Locking System) secures weapon once holstered; simple straight up draw once ALS is deactivated by thumb while obtaining shooting grip
- Injection-molded paddle design is highly concealable and rides close to body
- Injection-molded belt loop is user adjustable for cant and can be worn crossdraw
- IDPA approved
- Optional ALS® Guard available for increased security
- Genuine SafariLaminate™ thermal-molded construction with suede lining to help protect the gun's finish
- Available in STX finishes



PATENTED

NEW

6376 // HI-RIDE BELT SLIDE

- Rides 1" higher than standard belt slide
- Available in 1.5" (38mm) and 1.75" (45mm) belt widths

CONCEALMENT HOLSTERS

PADDLE



5198 // OPEN TOP CONCEALMENT PADDLE & BELT LOOP COMBO

- Detent in trigger guard for reliable weapon security
- Low cut sides for ease of draw and added comfort
- Belt loop is user adjustable for cant angle; can even be worn cross draw
- Injection-molded paddle design is highly concealable and rides close to the body
- IDPA approved
- Genuine SafariLaminate™ thermal-molded construction
- Available in STX finishes
- Model 5188 available for light mounted weapons



NEW

5196 // HI-RIDE BELT SLIDE

- Rides 1" higher than standard belt slide
- Available in 1.5" (38mm) and 1.75" (45mm) belt widths



NEW

566 // HI-RIDE BELT SLIDE

PATENTED

- Rides 1" higher than standard belt slide
- Available in 1.5" (38mm) and 1.75" (45mm) belt widths



568 // CUSTOM FIT PADDLE & BELT LOOP COMBO

- 6 pistol and 4 revolver fits accommodate over 200 different weapons
- Injection-molded paddle designed for concealability and comfort
- IDPA approved
- Genuine SafariLaminate™ thermal-molded construction with suede lining to help protect the gun's finish
- Available in STX Plain Black finish

PATENTED



5181 // OPEN TOP CONCEALMENT PADDLE HOLSTER

- Medium- to hi-ride carry
- Adjustable tensioning device provides excellent weapon retention
- SafariLaminate™ thermal-molded construction with suede lining
- Available in Plain Black finish



518 // THUMB BREAK CONCEALMENT HOLSTER

- Self-locking paddle offers easy insertion and removal of gun
- Adjustable tension device allows for customizing draw
- SafariLaminate™ thermal-molded construction with suede lining
- Available in Plain Black or STX Tactical® finishes



PATENT PENDING

578 // 7TS™ GLS™ MULTIFIT CONCEALMENT PADDLE & BELT LOOP COMBO HOLSTER

- GLS™ (Grip Lock System) secures weapon once holstered; retention is deactivated with the middle finger upon a standard shooting grip on the weapon
- Designed to fit multiple weapons in one holster, adjustment available to further customize fit
- Body is proprietary nylon blend that is non-abrasive to a firearm's finish, maintains very high heat tolerance, low cold tolerance
- Low-cut and compact design make concealment easy while also allowing for a quick draw
- Injection-molded paddle design is highly concealable and rides close to body
- Injection-molded belt loop is user adjustable for cant and can be worn cross draw
- Available in SafariSeven™ Plain Black and FDE Brown finishes

CONCEALMENT HOLSTERS

INSIDE POCKET & INSIDE WAISTBAND

ARMOR
COMMUNICATIONS
DUTY GEAR
BIKE
FIREARMS ACCESSORIES
LESS LETHAL
PROTECTIVE GEAR
FORENSICS
PERFORMANCE APPAREL
ARMOR SYSTEMS
SURVIVABILITY SYSTEMS
TRAINING GROUP



22 // WALLET PROFILE HOLSTER

- Back of holster is designed to give “print” impression of a wallet
- Hinged design allows backing to swing away from holster, making for a sure grip on the weapon and easy draw
- Holster will stay open; simply drop handgun into the pocket and it holsters itself
- Suede outer material grips clothing for less movement of holster
- Firm, moisture-proof membrane layer prevents perspiration from penetrating the holster and collecting on the gun
- Available in Black Suede finish



27 // INSIDE-THE-PANTS CONCEALMENT HOLSTER

- J-shaped belt hook can be worn with any belt
- Designed for undercover duty use with open-top design for quick access
- SafariLaminate™ thermal-molded construction
- A polymer insert keeps the holster open for easy weapon reholstering
- Available in Plain Black finish



18 // IWB HOLSTER

- Open-top design
- Firm SafariLaminate™ construction allows holster to stay open for ease of reholstering
- SafariSuede™ outer material grips clothing for less movement of holster
- Fits both 1.25" (32mm) and 1.5" (38mm) belt widths
- Double-snap belt loop is adjustable for holster cant
- Available in Black sueded finish

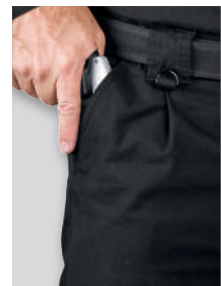

Low-Profile Draw

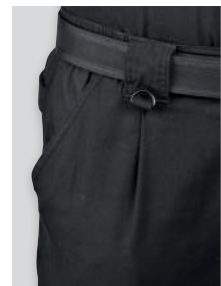

Shown in Pocket

25 // INSIDE-THE-POCKET HOLSTER

- Extra-thin, extra-soft holster for extra-deep concealment
- Holster will stay open; simply drop handgun into the pocket and it holsters itself
- Suede outer material grips clothing for less movement of holster
- Firm, moisture-proof membrane layer prevents perspiration from penetrating the holster and collecting on the gun
- Available in Black sueded finish

SHOULDER HOLSTERS



PATENTED



Can Be Worn Vertical or Horizontal

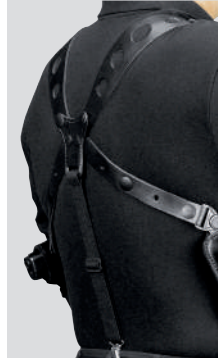

Back View

ALS
automatic locking system

1051

// ALS® SHOULDER HOLSTER

- ALS® (Automatic Locking System) secures weapon once holstered
- SafariLaminate™ thermal-molded construction for ease of draw and reholstering with one hand
- Vertical or horizontal carry options
- Harness system is comfortable and fully adjustable
- For pistols only
- Available in Plain or STX Plain Black finishes



PATENTED

1090

// GUN QUICK™ SHOULDER HOLSTER

- Engineered for medium- and large-frame pistols
- Fits more than 90 pistol designs
- Ambidextrous shoulder holster
- Easy-to-adjust barrel length and width
- Retention spring allows for easy one-handed reholstering
- For pistols only
- Available in Plain Black finish



PATENTED

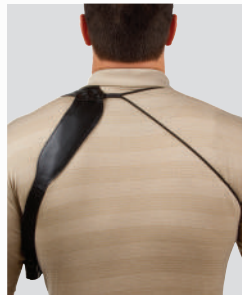

Back View

ALS
automatic locking system

1053

// ALS® UNIVERSAL SHOULDER HOLSTER

- ALS (Automatic Locking System) secures weapon once holstered
- Adjustable strap to fit most body types
- Lightweight elastic single side harness provides stability for handgun
- Harness and mounting system sold separately from holster and can be used with any ALS concealment holster (excluding revolvers)



PATENTED & PATENT PENDING

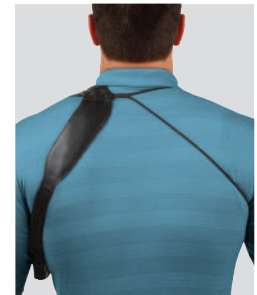

Back View

7TS

ALS
automatic locking system

7052

// 7TS™ ALS® LIGHTWEIGHT SHOULDER HOLSTER

- ALS (Automatic Locking System) secures weapon once holstered; simple straight out draw once ALS is deactivated by thumb while obtaining shooting grip
- Proprietary SafariSeven™ material nearly impervious to heat, cold and water
- One handed reholstering
- Lightweight, adjustable elastic single side harness provides stability for handgun
- Belt tie-downs not needed due to lightweight and compact design
- Available in SafariSeven Plain Black and FDE finishes

CONCEALMENT ACCESSORIES

ARMOR COMMUNICATIONS DUTY GEAR BIKE FIREARMS ACCESSORIES LESS LETHAL PROTECTIVE GEAR FORENSICS PERFORMANCE APPAREL ARMOR SYSTEMS SURVIVABILITY SYSTEMS TRAINING GROUP



574
// MAGAZINE HOLDER AND LIGHT POUCH - PADDLE

- Adjustable tension device
- Paddle design features a self-locking hook
- Fits belt widths up to 1.75" (45mm)



074
// OPEN TOP SINGLE MAGAZINE POUCH

- Paddle-style single magazine holder
- Fits belt widths up to 1.5" (38mm)
- Adjustable tension device
- Available in Plain Black or STX finishes

81 // OPEN TOP SINGLE MAGAZINE-SNAP

- Back side folds over to form snap-type belt loop
- For use on belts up to 1.75" (45mm)
- Available in Plain Black finish

CD-AUTO // AUTO MAGAZINE HOLDER

- Black metal clip-on design

079 // OPEN TOP DOUBLE MAGAZINE POUCH - SNAP

- For use on belts up to 1.75" (45mm) wide
- Adjustable tension device
- Available in Plain Black, Basketweave, or STX finishes



71
// INJECTION MOLDED SINGLE MAG POUCH

- Flexible "accordion" design allows for multiple fits and minimal size
- Fits magazines (single or double stack), flashlights, knives and multi-tools
- Available in Black or Tan
- Fits 1.5" (38mm) to 2.25" (58mm) belt widths
- Can now be ordered as a tactical accessory to be used with Safariland® leg shrouds or the QAS System; also available as an IWB, with a belt clip, or for use with the MSA



309
// COMPACT FLASHLIGHT HOLDER - PADDLE

- Detent around flashlight bezel creates security upon holstering
- Adjustable dual tension device
- Fits 1.5" (38mm) belt widths
- Available in STX finishes

123 // MAGAZINE POUCH - HORIZONTAL

- Carries magazines in a horizontal position
- Hook and loop belt attachment wraps around belt
- Available in Plain Black finish

572 // OPEN TOP DOUBLE MAGAZINE POUCH - PADDLE

- Adjustable tension device
- Available in Plain Black, Basketweave, or STX finishes

573 // MAGAZINE HOLDER & HANDCUFF POUCH

- Paddle design features a self-locking belt hook
- Adjustable tension device
- Available in Plain Black finish

590 // MAGAZINE HOLDER & HANDCUFF POUCH

- Paddle design features a self-locking belt hook
- Adjustable tension device
- Available in Plain Black finish



81



CD-AUTO



079

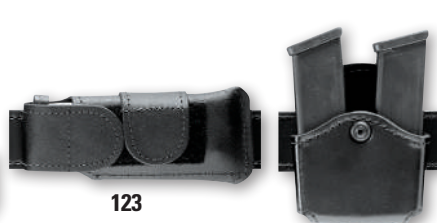

123



572

7350 // BADGE HOLDER

- Three sizes for star and shield
- Metal clip

7352 // BADGE HOLDER

- Shaped for shield-style badges

L820/L830 // PLAINCLOTHES BELT 1.25" (32mm) & 1.5" (38mm)

- SafariLaminate™ construction with a vegetable-tanned leather support to accommodate holsters for larger handguns
- Available in Plain Black with solid brass or chrome buckle



573



590



7350



7352

851 // CONTOURED DRESS BELT 1.5" (38mm)

- Made of the long-lasting and easy-to-care for SafariLaminate™ with a 7/8" vegetable tanned leather liner to provide stability for handguns
- Curved to fit the contours of the body
- Two hidden cuff keys
- Available in Plain Black with solid brass or chrome buckle



L820/L830



851



TEAM SAFARILAND

Since its inception in 1985, Team Safariland has been an integral part of developing and testing competition products. Safariland continually pushes the envelope with new and innovative competition holsters and accessories. Our newest gear, the ELS Competition belt, has raised the bar competition equipment, and the Model 014 Open Class holster brings a technological-edge to competitors.



TOM CAMPBELL

- 2001 USPSA Limited 10 National Champion
- 1977-1988 Member of USPSA Shooting Team
- 1985 European Champion
- 1986 USPSA Team Captain
- 24 years at Safariland, over 46 years total in the industry



SCOTT CARNAHAN

- Team Safariland Captain
- 3-Time USPSA National Class Champion
- NRA Open Action Pistol Distinguished Badge #103
- 2009 Bianchi Cup National Class Champion
- 2012 NRA USA Action Pistol World Team Member for the Bianchi Cup



JULIE GOLOB

- First and only Six Division USPSA Female National Champion
- 13-Time USPSA Ladies National Champion
- 3-Time Bianchi Cup Ladies Champion
- 7-Time Ladies World Speed Shooting Champion
- 4-Time IDPA Ladies National Champion



DOUG KOENIG

- 2013 and 15-Time Bianchi Cup Champion
- 2013 and 5-Time European Bianchi Cup Champion
- 3-Time Steel Challenge World Speed Shooting Champion
- 1990 IPSC World Champion
- 2014 and 6-Time World Action Pistol Champion



ROB LEATHAM

- First and only Six Division USPSA National Champion
- 2014 USPSA Revolver National Champion
- 26-Time USPSA National Champion
- 2014 Bianchi Cup Production and 9-Time Bianchi Cup Champion
- 2014 IPSC World Champion
- 2011 Steel Challenge ESP Champion and 8-Time Steel Challenge Champion



KIPPI LEATHAM

- 2014 Western States Single Stack Classic Runner Up
- 2011 USPSA Area 3 Production Ladies Champion
- 2011 USPSA Ladies Production World Team, IPSC Silver Medalist
- 4-Time USPSA National Ladies Champion
- 4-Time USA IPSC Gold Team Member and Women's World Team Champion



KENDA LENSEIGNE

- 2014 CMSA Western Championships Double Down Champion
- 2014 CMSA World Champion
- 2009 CMSA and 3 time Overall World Champion and holder of 13 world records
- 2010 CMSA Overall National Champion
- 2012 and 2013 CMSA's Western US Overall Champion
- 4 - time CMSA World Point Champion Cowgirl



BOBBY MCGEE

- 2013 and 2-Time Puerto Rico IDPA ESR National Champion
- 2013 AZ State IDPA ESR Champion
- 2012 Arizona State IDPA Champion
- 2012 Golden Gate IDPA Champion
- 6-Time Washington State IDPA Champion



MAGGIE REESE

- Top Shot Contestant, Season 2
- 2014 USPSA Ladies Production World Team, IPSC
- 2011 Rocky Mountain 3-Gun Ladies Champion
- 2-Time USPSA National Ladies Multigun Champion
- 3-Time Ironman's 3-Gun "Iron Maiden" Champion



BILL ROGERS

- Author of "Be Fast, Be Accurate, Be The Best"
- Author of "Reactive Pistol Shooting" video by Panteao
- Author of "Reactive Rifle Shooting" videos by Panteao
- Rogers Shooting School - 1976 - present: Owner, operator and lead instructor
- Inventor of, and patented the "Kydex" holster



BOB VOGEL

- 2014 Pro AM Championships Champion
- IPSC World Champion and IDPA World Champion
- 4-Time USPSA National Champion
- 6-Time IDPA National Champion
- 6-Time Indoor IDPA National Champion



MICHAEL VOIGT

- 2014 IPSC World Champion
- 2014 Ironman Senior Open Champion
- 2013 and 13-Time USPSA MultiGun National Champion
- 2013 and 3-Time Iron Man 3-Gun Champion
- 6-Time IPSC World Shoot Gold Medal Winner as part of US Team
- 2013 and 3-Time Texas State MultiGun Champion

COMPETITION RIGS

Team Safariland has completed another year of extensive field testing and shooting in competitive events, with the ELS System at the core. The combinations with this system are endless and it's changing the way shooters are rigging up for competitions.



Photo: Yamil Sued



ARMOR
COMMUNICATIONS
DUTY GEAR
BIKE
FIREARMS ACCESSORIES
LETHAL
PROTECTIVE GEAR
FORENSICS
PERFORMANCE APPAREL
ARMOR SYSTEMS
SURVIVABILITY SYSTEMS
TRAINING GROUP



Production/Single Stack Division Rig

The Production division is shot with standard handguns. Most popular in the division are Glocks, Smith & Wesson M&Ps, and Springfield XD's. Production division rigs are similar to Single Stack rigs with the exception of the handgun; in the Single Stack division a traditional 1911 is used. For both divisions, team members use the model 5197 holster mounted to a QLS System or the 5199 with belt clip. Most of us use the Model 771 pouch with the open front in the first reload location, and the Model 773 closed front pouches, which provide extra security for the rest of the magazines. Rob Leatham even likes this set up for L-10. Keeping the handguns and magazines in the same location enables the shooter to focus more on the competition and not relearning different positions.



Bianchi Cup Open Division Rig

The Bianchi Cup Open Division gun is a piece of art, generally a 1911 with a shroud for the barricade event, and an electronic red dot sight, these guns are truly a sight to be seen. The Metallic division is based on the 1911 with iron sights. For Bianchi Cup Open or Metallic divisions, either mount your 014 holster using the belt included, or as Doug Koenig prefers, mount the vertical adjustment rod directly to the belt. We use either the Slimline pouches that hold the magazines perpendicular, facing out from the belt, or the new Model 776 mag pouch, allowing us to carry eight magazines in a small area of space.



Multi-Gun Rig

When it comes to Multi-Gun competitions the versatility of the ELS System really comes into play. One of the biggest challenges with 3-Gun competitions is reconfiguring your rig for each course of fire. Not so with our ELS and QLS Systems. For Open Division 3-Gun competition, Mike Voigt likes to mount the 014 holster to a QLS Fork so that he can easily remove the holster when changing to stages where it's not needed. Speed is always paramount in competitions; this was a key factor in the design of the Model 6005-12. Both Mike Voigt and Maggie Reese, working very closely with the Safariland R&D team helped to design this model, which they currently use in 3-Gun competitions. Mike also uses the models 773 and 774 handgun and rifle pouches to further give him the edge needed to win matches.

For Tactical Scope Multi-Gun rig, we either use a thigh rig, featuring the Drop Flex Adapter, and either a 5197 or 6354 holster which provides added protection to the handgun, or mount a 014 using the QLS System as Mike Voigt does. We also have the option to mount a leg shroud on the left side to carry more ammo if needed.



IDPA Division Rig

IDPA shooting simulates self-defense scenarios and real life encounters using off the shelf handguns in a concealed manner. The holsters, belts, and magazine pouches used in this sport are from our concealment line, and are not what we typically refer to as competition equipment. Team Safariland has been hard at work developing new products and creating new features which incorporate the needs of IDPA shooters. The Range Series which includes the 5195, 5197 holsters and the 332 belt are all new for 2013 and well-suited for IDPA. These holsters and belt, used in conjunction with some of Safariland's tried and true pouches like models 079, 074 or 773 with the 744BL Belt Clip attached, is a winning combination for any IDPA shooter.



For USPSA handgun, Multi-Gun and Steel Challenge it all starts with the model 030 under belt. Next is the 032 ELS Competition outer belt. We designed it to be very strong to hold your holster and high capacity magazines in place, yet light and comfortable. Finally by attaching the Quick Locking Kit for larger capability and the Equipment Locking Kits for pouches and shell holders, a truly modular system is attained. This system makes it easy to change out holsters and accessories for whatever the course of fire calls and the ability to change from division to division.

Rob Leatham

Vice President Marketing, Equipment Products

COMPETITION HOLSTERS



5197 // RANGE SERIES OPEN TOP MID RIDE HOLSTER

- Adjustable belt loop eliminates common belt-bulging and does not interfere with draw
- Compact and lightweight
- Detent in trigger guard for reliable weapon security
- Low cut sides for ease of draw and added comfort
- Available in 1.5" (38mm) or 1.75" (45mm belt widths)
- Belt loop is user adjustable for cant angle; can even be worn cross draw
- IDPA approved
- Genuine SafariLaminate™ thermal-molded construction
- Available in STX finishes



5195 // RANGE SERIES OPEN TOP LOW RIDE HOLSTER

- Compact and lightweight
- Low cut sides for ease of draw
- Offset belt loop allows for a straight up draw
- Detent in trigger guard for added security
- Modular offset adapter accommodates the QLS19 locking fork, 745BL and 567BL
- IDPA approved; recommended for female shooters
- Available in STX finishes



014 // OPEN CLASS COMPETITION HOLSTER

- Body machined out of aluminum to stabilize the handgun, yet offers little resistance for a secure and fast draw
- Ball joint on holster allows complete freedom of movement to customize the handgun draw
- Fully adjustable nosepiece accommodates barrels from 5" to 7.5" (13cm – 19cm)
- Fits a variety of competition handguns, with or without red dot or magnified optics
- Injection-molded adjustable trigger guard lock
- Front nosepiece designed to retain handgun and help prevent gun from being knocked out of the holster once seated
- Incorporates a simple push lock which secures weapon into the trigger block
- Also available for Glock and S&W M&P
- Available in Black or Red finishes

Legal for the following divisions: Bianchi Cup Open Division, Steel Challenge Limited and Open Division, USPSA Open, Limited, & Limited-10 and USPSA Multi-Gun All Divisions

PATENT PENDING



WCM // WHEEL CHAIR COMPETITION MOUNT

- Adjustable clamp system for use on vertical or horizontal sections of wheelchair armrest or frame
- ELS Fork and Receiver on mounting bracket for quick removal of holster, weapon and mag pouches between stages
- Height adjustability for holster and mag pouches
- Heavy duty design to ensure very limited movement while drawing
- Fits frame tubes from .75" to 1.25"
- Ambidextrous
- Designed to work with 5198 holsters for production class guns and 014 holsters for open or limited division



Holsters and magazine pouches not included



002 // CUP CHALLENGE COMPETITION HOLSTER

- Features dual-tension screws on the holster body, one in back of cylinder and the other in back of barrel, allowing a balanced retention of the handgun
- Loop lined belt tab provides a firm and adjustable carry when used with the Safariland Model 032 hook-lined competition belt
- Accommodates both scoped and non-scoped revolvers as well as most revolvers with standard, heavy, and slab side barrels
- Built-in removable muzzle strap protects front sights
- Available in STX Tactical® or STX Basketweave finishes



4556 // 3-GUN COMPETITION CASE

- Heavy-duty lockable zippers, two adjustable outside accessory pouches
- Large dual handgun/accessory pouch with enclosed handgun storage areas and 4 pistol mag pouches large enough for extended magazines
- Unique zippered barrel expansion slot allows for barrels up to 51"
- 46" overall length (with expansion slot closed)

SEE MORE ON PAGE 83



4555 // SHOOTERS' RANGE BAG

- Removable center carry compartment has zippered, padded side panels for 4 separate handgun compartments
- Magazine pouches sewn into main storage area
- Two large exterior pockets and a fully lined interior
- Overall dimensions: 14" x 9" x 10"

SEE MORE ON PAGE 82



776 // COMPETITION MAGNETIC MAGAZINE HOLDER

- Magazines are oriented "bullets out" to save space on belt
- Designed with internal magnets to be used as a tension device
- Durable nylon construction with hook and loop closure
- Includes a snap loop attachment to hold flap in place
- Available with 744BL Belt Clip or ELS 34 Locking fork



774 // RIFLE MAG POUCH

- Available in Black, Foliage Green or, FDE Brown, or Coyote Brown finishes

SEE MORE ON PAGE 82



771/773 // OPEN TOP SINGLE MAGAZINE POUCH

- Features two magazine tensioning screws on back side of the holster to adjust tension on both the middle and end of the magazine
- Built-up channel for clearance of the bullet during the draw
- Available in STX Tactical or STX Basketweave finishes

NEW



334 // RIGID COMPETITION BELT 1.5" (38mm)

- Reinforced to hold heavy competition handguns and ammunition
- Single Safariland® branded keeper
- Hook liner for use with Safariland 030 underbelt (like on 032)



032 // ELS COMPETITION BELT 1.75" (45mm)

- Reinforced to hold heavy competition handguns and ammunition
- Hook lined to attach to 030 underbelt
- Pre-cut holes to mount ELS 35 Receiver Plates in multiple locations and angles
- Available in Nylon Look and Basketweave finishes



332 // RANGE BELT 1.5" (38mm)

- Reinforced to hold heavy competition handguns and ammunition
- Highly tactile interior to grip clothing
- Available in Nylon Look, Basketweave, Foliage Green, and FDE Brown finishes



030 // BUCKLELESS™ COMPETITION UNDERBELT 1.5" (38mm)

- Loop on outer side to connect to model 032
- Available in Black with web finish



COMPETITION ACCESSORIES



778

// DUAL OPEN FRONT MAGAZINE POUCH

- Utilizes 90° adjustable belt loop
- Magazines sit against plastic rollers that reduce drag during draw
- Two sets of tension screws on pouches are threaded through rollers for adjustment and fast reloads
- Closed low-cut front on pouches helps secure magazine and prevents it from being knocked out of the front of pouch
- Fits belt widths up to 1.5" (38mm)
- Available in STX Tactical® or STX Basketweave finishes



779

// DUAL OPEN TOP SINGLE MAGAZINE POUCH

- Magazines sit against plastic rollers that reduce drag during draw
- Features two tensioning screws on back side of the holder to adjust tension on both the middle and end of the magazine
- Open-front design keeps index finger from touching the holder during reload, ensuring fast reload
- Fits belt widths up to 1.5" (38mm)
- Available in STX Tactical® or STX Basketweave finishes



778A

// ADAPTER PLATE

- Attaches to Model 771 or 773 converting it to a dual magazine pouch
- Fits 1.5" (38mm) belt widths



075-2

// HEARING PROTECTION HOLDER

- Clips on to belt
- Available in Black



085

PATENT PENDING



084



080-12



081-12

084/085

// SHOTGUN SHELL HOLDER

- Provides (4) or (6) 12-gauge shells when needed
- All shells can be grasped and employed at once
- Available on an ELS 34 Locking Fork, 744BL Belt Clip, ELS 34/ELS 35 Locking Fork and Plate combo, or plain for direct leg shroud mounting
- Tensioners provide solid retaining system to hold shells, even when some are removed on model 085
- For use with 2 3/4" shells

080-12/081-12

// SHOTGUN SHELL HOLDER

- Molded shotgun shell holder holds (2) 12-gauge shells
- Belt clip features an extended bottom hook for security
- Fits belts up to 2.25" (58mm) wide
- 081-12 features mounting holes



PATENT PENDING

6005-12

// SHOTGUN SPEEDLOADER HOLDER

- Designed to be worn on the thigh
- Provides quick access to up to 5 shotgun speedloaders
- Cup and retention clip system keeps loaders stable, even while running
- Includes ELS 34 Fork on leg strap to work in conjunction with 032 ELS Competition Belt or can also be used with conventional competition belts using existing belt loop



J-KTR, J-LP

// SHOOTERS LOADING BLOCK

- Convenient trays hold wadcutter, semi-wadcutter or round nosed .38 or .357 ammunition
- Popular for all speedloaders



COMP I



COMP II



COMP III

COMP I / II / III

// SPEEDLOADER

- Injection-molded construction
- Large-frame versions offer maximum grip clearance



HARDWARE KIT

- Kit provides the necessary materials: screws, rollers, washers, T-nuts, hook and Allen wrench to service Safariland holsters



TS-9250/9255

// SAFARILAND® HAT

- Adjustable size fits all
- Low-profile design
- Embroidered logo on front and Safariland on back and on edge of bill
- Available in Black and Tan



DVD

// TRAINING DVDS

- Wide selection of informative training DVDs available



Back

TS-2900

// SAFARILAND® LONG SLEEVE PERFORMANCE SHIRT

- Team Safariland competition long-sleeved shirt
- Moisture-wicking fabric helps keep the wearer cool in hot environments and warm in cold ones
- Black with silk-screened Safariland logo on front, back and forearms
- Available in sizes S-XXL



TS-3200

// SAFARILAND® PERFORMANCE T-SHIRT

- Moisture-wicking fabric helps keep the wearer cool in hot environments and warm in cold ones
- Black with silk-screened Safariland logo on upper front chest and upper back
- Available in sizes S-XXL



TS-6600/ TS-6610

// SAFARILAND® MEN'S / WOMEN'S PERFORMANCE POLO SHIRT

- Moisture-wicking fabric helps keep the wearer cool in hot environments and warm in cold ones
- Black with embroidered Safariland logo on upper left chest
- Available in sizes S-XXL



TS-6830

// SAFARILAND® MEN'S POLO SHIRT

- 100% polyester wicks away perspiration to keep you cool in the heat and warm when it's cold
- Safariland logo on chest, back, and arm of shirt
- Large diagonal background Impala logo across front and back of shirt
- Available in White
- S-2XXL



SAF-CUP-MUG

// COFFEE MUG

- Matte Black finish with Safariland logo in red and liquid gold on both sides
- Ceramic
- 17 oz. capacity



SAF-CUP-2

// COFFEE TUMBLER

- 16 oz. stainless tumbler with Matte Black finish
- Safariland logo printed in red and liquid gold on one side